

OPERATING MANUAL

FALCON SW

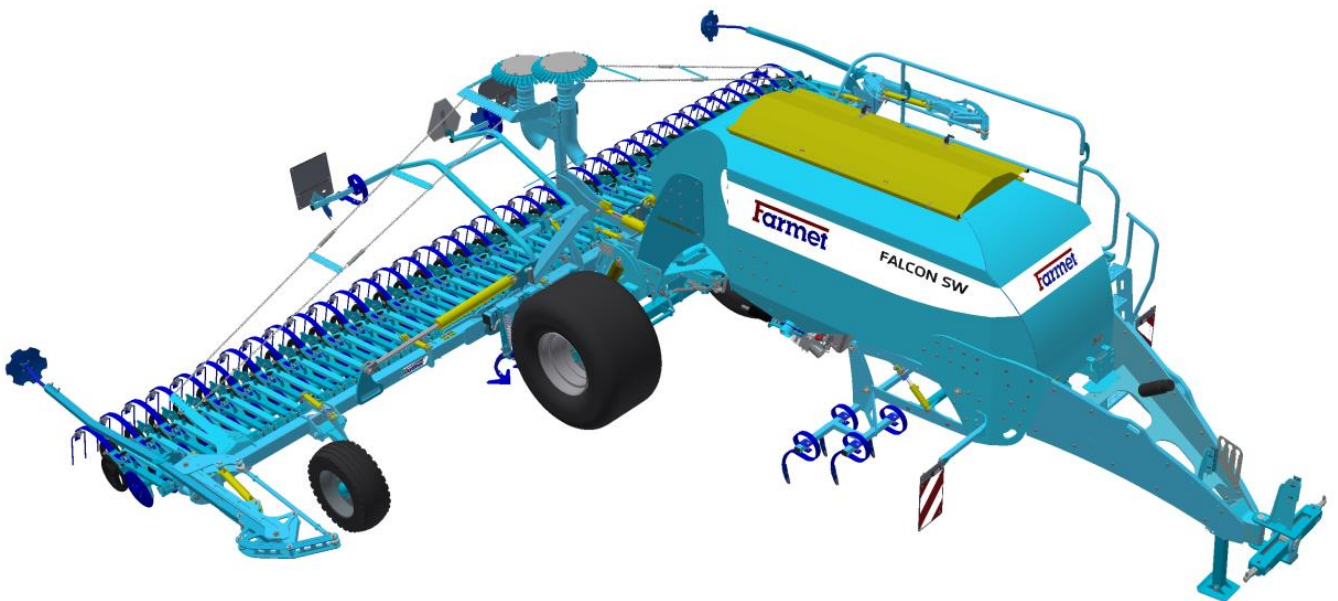

Edition: 1 | effective from: 1. 5. 2017

Dear customer,

The **FALCON SW** disc sowing machines are high-quality products by Farmet a.s. Česká Skalice.

You can start to fully use the qualities of your machine after you have thoroughly studied the operating manual. **The serial number of the machine is imprinted on the production label and recorded in the operating manual. Please use this serial number whenever you order spare parts in case of a repair. The production label is located on the central frame near the pole.**

Use only spare parts for these machines according to the *Spare Part Catalogue* officially published by the producer, the company Farmet a.s. Česká Skalice.

Possibilities of Use of Your Machine

The disc sowing machines are intended for areal sowing with the option to sow broad-line cultures into strips. The sowing machine is intended for sowing a wide range of farming products, such as cereal, pulses, oil bearing crops, clover crops, grass etc. The actual conditions for sowing individual farming products are stated below. The machine is intended for aggregation with tractors with the output from 161 kW to 216 kW according to the soil conditions and depth of sowing. The optimal working speed is 10 - 20 km/hour. The machine allows additional fertilising by granulated fertilisers while sowing.

CONTENT

CRITICAL PARAMETERS OF THE MACHINE	5
Technical parameters	5
Safety warning.....	6
A. GENERAL INSTRUCTIONS FOR USE	6
Protective equipment.....	7
B. TRANSPORTING THE MACHINE.....	7
C. MANIPULATING THE MACHINE BY LIFTING EQUIPMENT	7
D. TRANSPORTING THE MACHINE ON GROUND COMMUNICATIONS	7
E. WORK SAFETY LABELS.....	8
1. DESCRIPTION OF THE MACHINE	11
Working parts of the machine.....	11
2. ASSEMBLY OF THE MACHINE AT THE CUSTOMER'S SITE.....	12
3. PUTTING INTO OPERATION	12
3.1. Aggregation to the tractor	13
3.2. Connecting the hydraulics.....	14
3.3. Connecting the electronic unit.....	14
3.4. Manipulating the machine from a truck	15
3.5. Connecting the hydraulic motor of the fan.....	16
4. ELECTRONIC SYSTEM OF THE MACHINE	19
4.1. Description of machine control by Müller electronics	21
4.2. Description of the basic display	21
4.3. Controlling hydraulics	22
4.3.1 Controlling markers	22
4.4. Rail lines setting system	24
4.4.1 Setting rail lines rhythm.....	25
4.4.2 Setting Rail Lines	31
4.5. Reference date	32
4.5.1. Creating an order.....	32
4.5.2. Level of seeds in the hopper	33
4.6. Setting passage sensors.....	33
4.6.1 Seeding sensor diagnostics	35
4.6.2 Switching off the seed flow system sensors	35
4.6.3 Designation of motors and dosers.....	36
5. UNFOLDING AND FOLDING MACHINE	36
5.1. Unfolding the machine.....	37
5.2. Folding the machine.....	38
6. LOWERING AND LIFTING	39
6.1. Lowering the machine.....	39
7. FILLING UP THE SEED/FERTILIZER CONTAINER	39
8. SETTING OF THE SOWING BATCH	40
8.1. Screw disperse for side-dressing	45
8.2. Setting the fine seeds sowing.....	46
9. SETTING VENTILATOR SPEED ACCORDING TO SEEDS	47
10. ADJUSTMENT OF THE WORKING PARTS OF THE MACHINE.....	48
10.1. Adjusting the machine work depth	48
10.2. Adjusting the machine by TPS arms of the tractor.....	49
10.3. Setting the third point piston rod	49
10.4. Setting the sowing depth	50
10.5. Setting the down-pressure of the sowing bodies.....	52
10.6. Setting the leveller behind the seed boots	53
10.7. Adjusting the working depth of the front section.....	53
10.8. Setting the machine track cultivators	54
10.9. Setting of the markers.....	55
11. SUMMARY OF TASKS BEFORE THE COMMENCEMENT OF WORK	56
12. ERRORS	57
13. COMPLETION OF SOWING.....	63
14. MAINTENANCE AND REPAIRS OF THE MACHINE.....	64
14.1. Replacement of worn discs	65

14.2. The pressure in the tyres.....	65
14.3. Manipulation with lubricans:	66
14.4. The pressure in the tyres.....	66
15. STORING THE MACHINE	66
16. PROTECTION OF ENVIRONMENT	66
17. DISPOSAL OF THE MACHINE AFTER THE END OF ITS USABLE LIFE	66
18. MAINTENANCE AND TERMS OF GUARANTEE.....	67
18.1. Maintenance	67
18.2. Guarantee	67
19. SPECIAL SPECIES OF SOWING	68
19.1. Setting the strip.....	68
19.2. Sowing two different seed of seeds	73
20. STRATEGIC SPARE PARTS	77
LETTER OF GUARANTEE	79
CE CERTIFICATE OF CONFORMITY	80

CRITICAL PARAMETERS OF THE MACHINE

- ^(x) The machine is designated for sowing common cereals and broad-line cultures in aggregation with an agricultural wheel or caterpillar tractor. Another type of use exceeding the determined purpose is forbidden.
- ^(x) The machine is only operated by one person – the tractor driver.
- ^(x) The operator must not use the machine for other purposes, particularly:
 - ^(x) For transporting people and animals on the construction of the machine,
 - ^(x) For transporting load on the construction of the machine,
 - ^(x) Aggregation of the machine with other tractive equipment than stated in Chapter “3.1/p.13”.

TECHNICAL PARAMETERS

Tab. 1 – Technical parameters of the machine

PARAMETERS	FALCON SW 6	FALCON SW 8	FALCON SW 9
Working width (mm)	6000	8000	9 000
Transport width (mm)	3 000	3 000	3 000
Transport height when third-point piston rod is drawn out (mm)	2 900	3 600	4 000
Total length of the machine (mm)			
Working depth (mm)	0 – 100	0 – 100	0 – 100
Container capacity without fertilization / with fertilization (l)	4 000 / 6000	4 000 / 6000	4 000 / 6000
with fertilization (mm)	2 650	2 650	2 650
Dimensions of the filling opening (m)	2,02 x 0,62	2,02 x 0,62	2,02 x 0,62
Number of drill coulters (spacing 125 / 150 mm)	48 / 40	64 / 54	72 / 60
Pressure of drill coulters / fertilizer boots (kg)	50 -115 / až 200	50 -115 / až 200	50 -115 / až 200
Diameter of the sowing disk, two-disk coulters / press-wheel (mm)	360 / 340	360 / 340	360 / 340
Working capacity (ha/h)	9 – 18	9 – 18	9 – 18
Pulling vehicle (kW)	161 / 216 *	161 / 216 *	161 / 216 *
Working speed (km/h)	10 – 20	10 – 20	10 – 20
Maximum transport speed (km/h)	25	25	25
Maximum slope accessibility (°)	6	6	6
Tyre dimensions	560/60-22,5	560/60-22,5	560/60-22,5
Type of brakes / distribution ¹⁾	air / two-line***	air / two-line***	air / two-line***
Required pressure (kPa)	8,5***	8,5***	8,5***
Number of hydraulic circuits / pressure (bar)	5 / 200	5 / 200	5 / 200
Number of quick-coupling devices / type	8 / ISO 12,5	8 / ISO 12,5	8 / ISO 12,5
Non-pressure return line (max. 5 bar)	1 / ISO 20	1 / ISO 20	1 / ISO 20
Hydraulic fan oil flow (l/min)	30 - 40	30 - 40	30 - 40
Oil flow for machine control (l/min)	50 - 60	50 - 60	50 - 60
Electric system requirement	12 V DC / 40 A	12 V DC / 40 A	12 V DC / 40 A
Tractor suspension requirement	TBZ kat. 3	TBZ kat. 3	TBZ kat. 3
Machine weight	6500kg	6900kg	7140kg

** recommended pulling vehicle, the actual pulling force may significantly change according to the selected version of the machine, processing depth, soil conditions, inclination of land, wear and tear of the working parts and their adjustment*

*** weight of the machine according to accessories*

**** hydraulic brake alternative / operating pressure 130±5 bar*

Technical Advice!

¹⁾ **Transport/Brake System:** Follow the national regulations valid for transportation of machines on public roads. Check the legal provisions valid in the country and regulations on maximum permissible total axle weights and loads and also on the necessary potential use of a brake system. If you have any further questions, please contact our sales representative.

SAFETY WARNING



This warning symbol warns against an imminent dangerous situation that could lead to death or serious injury.



This warning symbol warns against a dangerous situation that could lead to death or serious injury.



This warning symbol warns against a situation that could lead to a small or minor injury. It also points out dangerous tasks related to the activity that could lead to an injury.

A. GENERAL INSTRUCTIONS FOR USE

A.1 ^(x) The machine is produced in compliance with the latest technological conditions and approved safety regulations. However, the use of the machine may still cause injuries to the user or third persons or damage to the machine or occurrence of other material damages.

A.2 ^(xx) Use the machine only in a technically unexceptionable condition, in compliance with its purpose, with awareness of potential risks and observance of safety instructions stated in this manual!

The Manufacturer is not liable for damages caused by the use of the machine that is in contradiction with the limit parameters of the machine (p. 5) and with the instructions for the use of the machine (Chapter A and 3). The User bears the risk.

Immediately eliminate all defects that could have a negative impact on safety!

A.3 ⁽⁷⁾ The machine may only be operated by a person authorized by the owner under the following conditions:

- ⁽⁸⁾ He or she must have a valid driving licence in the relevant category,
- ⁽⁹⁾ He or she must be verifiably informed on the safety rules of working with the machine and must have command of the operation of the machine in practice,
- ⁽¹⁰⁾ The machine must not be operated by a minor (minors),
- ⁽¹¹⁾ He or she must understand the meaning of warning symbols placed on the machine. Respecting the symbols is important for a safe and reliable operation of the machine.

A.4 ⁽¹²⁾ Maintenance and service repairs may only be performed by a person:

- ⁽¹³⁾ Authorized by the owner,
- ⁽¹⁴⁾ Trained in an engineering field with the knowledge of repairs of similar machinery,
- ⁽¹⁵⁾ Verifiably informed on the safety rules of working with the machine,
- ⁽¹⁶⁾ With a driving licence in the relevant category for repairs of the machine attached to a tractor.

A.5 ⁽¹⁷⁾ The operator of the machine must ensure safety of other people during the work with the machine and its transportation.

A.6 ⁽¹⁸⁾ During machine work in the field or during transport, the operator must control the machine from the tractor's cabin.



A.7 ⁽¹⁹⁾ The operator may only enter the construction of the machine when the machine is off and secured against movement only in order to:

- ⁽²⁰⁾ adjust the working parts of the machine,
- ⁽²¹⁾ repair and maintain the machine,
- ⁽²⁹⁾ release or secure the ball valves of the axle,
- ⁽²⁷⁾ secure the ball valves of the axle before tilting the side frame,
- ⁽²⁸⁾ adjust the working parts of the machine after opening the side frame.



A.8 ^(xxx) When climbing onto the machine, do not step on the tyres of the rolls or other revolving parts as they may roll over and you can seriously hurt yourself if you fall down.

 **A.9** ⁽²²⁾ Any changes or adjustments of the machine may only be performed with a written consent of the producer. The producer is not responsible for any potential damages occurred as a result of non-compliance with this instruction. The machine must always be equipped with the prescribed accessories, equipment and gear including the safety labels. All warning and safety signs must be always legible and at their positions. They must be replaced if damaged or lost without delay.

A.10 ⁽²³⁾ The operating manual and the requirements of the safety at work must be always available to the operator.



A.11 ⁽²⁴⁾ When operating the machine, the operator must not consume alcohol, medicine, narcotic and hallucinogenic substances that reduce attention and coordination abilities. If the operator has to take medicine prescribed by the physician or if he or she uses over the counter medicine, he or she must be informed by the physician whether he or she is able to reliably and safely operate the machine under these circumstances.



PROTECTIVE EQUIPMENT

For the operation and maintenance use:

- Close-fitting clothing
- Protective gloves and goggles for protection from dust and sharp parts of the machine



B. TRANSPORTING THE MACHINE

B.1 ⁽¹⁾ The vehicle intended for the transportation of the machine must have at least the same bearing capacity as the weight of the transported machine is. The total weight of the machine is stated on the production label.

B.2 ⁽²⁾ The dimensions of the transported machine including the vehicle must comply with valid regulations for traffic on ground communications (decrees, acts).



B.3 ⁽³⁾ The transported machine must be always attached to the vehicle so that it cannot be released during transportation.

B.4 ⁽⁴⁾ The carrier is responsible for damages caused by the release of incorrectly or insufficiently attached machine to the vehicle.

C. MANIPULATING THE MACHINE BY LIFTING EQUIPMENT

C.1 ⁽¹⁾ The lifting equipment and binding instruments intended for manipulation with the machine must have at least the same bearing capacity as the weight of the manipulated machine is.



C.2 ⁽²⁾ The machine may only be attached for manipulation in designated places marked by stick-on labels showing a "chain". 

C.3 ⁽³⁾ When attached (suspended) in designated places, it is not allowed to move in the area of potential reach of the manipulated machine.

D. TRANSPORTING THE MACHINE ON GROUND COMMUNICATIONS

Transport Position of **FALCON SW**

- Attach the machine to the tractor by hanging with the use of the two-point suspension equipment (TPS 3).
- The side frames must be folded in the vertical position.
- The machine must be equipped with removable shields displaying the boundaries, functional lighting and a board of rear label for slow vehicles (pursuant to EEC No.69).
- The lighting must be turned on when in operation on ground communications.
- The tractors must be equipped with a special light appliance with orange colour that must be turned on when in operation on ground communications.



- The operator must drive with increased caution and consideration for other participants of the traffic.
- The operator must secure the arms of the rear TPS of the tractor in the transport position when operating on ground communications. At the same time, the arms of the rear TPS of the tractor must be secured against swinging sideways.



- **It is strictly forbidden to transport people or load on the machine or connect another machine, semi-trailer or additional equipment to it.**
- The maximum transport speed during travelling on roads is **25 km/hour**.
- **Ban of transport with decreased visibility!**

E. WORK SAFETY LABELS

Warning safety labels are used for the protection of the operator.

The following applies generally:

A) Strictly observe the warning safety labels.

B) All safety instructions also apply to other users.

C) If the aforementioned "SAFETY LABEL" located on the machine is damaged or destroyed, THE OPERATOR MUST REPLACE IT WITH A NEW ONE!!!

The position, appearance and exact meaning of work safety labels on the machine are given in the following tables (Tab.2/p.8-9) and the picture (Picture 1,2/p.10).

WARNING SAFETY LABEL	TEXT TO THE LABEL	POSITION ON THE MACHINE
	Read carefully the operating manual before manipulation with the machine. Observe the instructions and safety rules when operating the machine.	P 1 H
	Driving the machine and transportation on its construction is strictly forbidden.	P 37 H
	When connecting and disconnecting, do not enter the area between the tractor and the machine. Do not enter that area unless the tractor and the machine are not moving and the engine is off.	P 2 H
	Stay beyond reach of the set Tractor – Agricultural Machine when the tractor engine is running.	P 6 H
	Secure the axle of the machine against an unexpected drop before its transportation.	P 13 H
	Secure the machine against unwanted movement.	P 52 H

	<p>Do not approach the rotary parts of the machine unless they are standing still, i.e. they are not rotating.</p>	<p>P 53 H</p>
	<p>Stay beyond reach of the lifted machine.</p>	<p>P 4 H</p>
	<p>When folding and unfolding the side frames and service bridge, stay beyond their reach.</p>	<p>P 50 H</p>
	<p>When tipping the service bridge, stay beyond its reach.</p>	<p>P 20 H</p>
	<p>When working with the machine as well as during its transportation, keep a safe distance from electric appliances.</p>	<p>P 39 H</p>
	<p>It is forbidden to fold and unfold the side frames of the machine on a slope or an inclined plane.</p>	<p>P 100 H</p>
	<p>Pictured positions of the lever and the hydraulic ball valve function located on the piston-rod.</p>	<p>P 101 H</p>

Picture 1

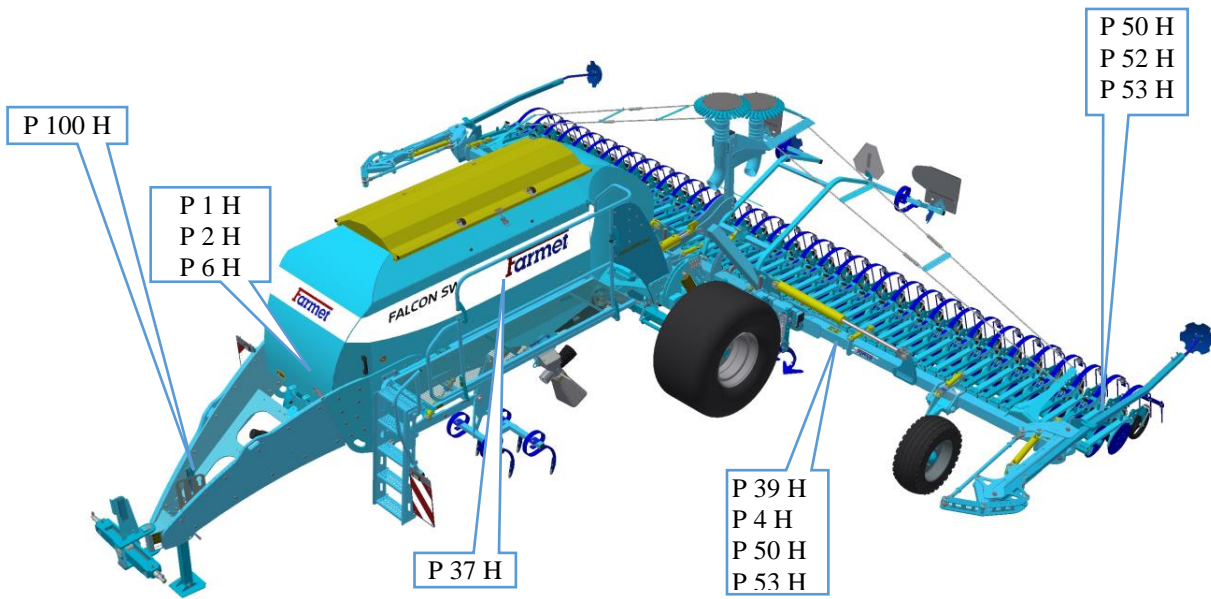

Picture 2

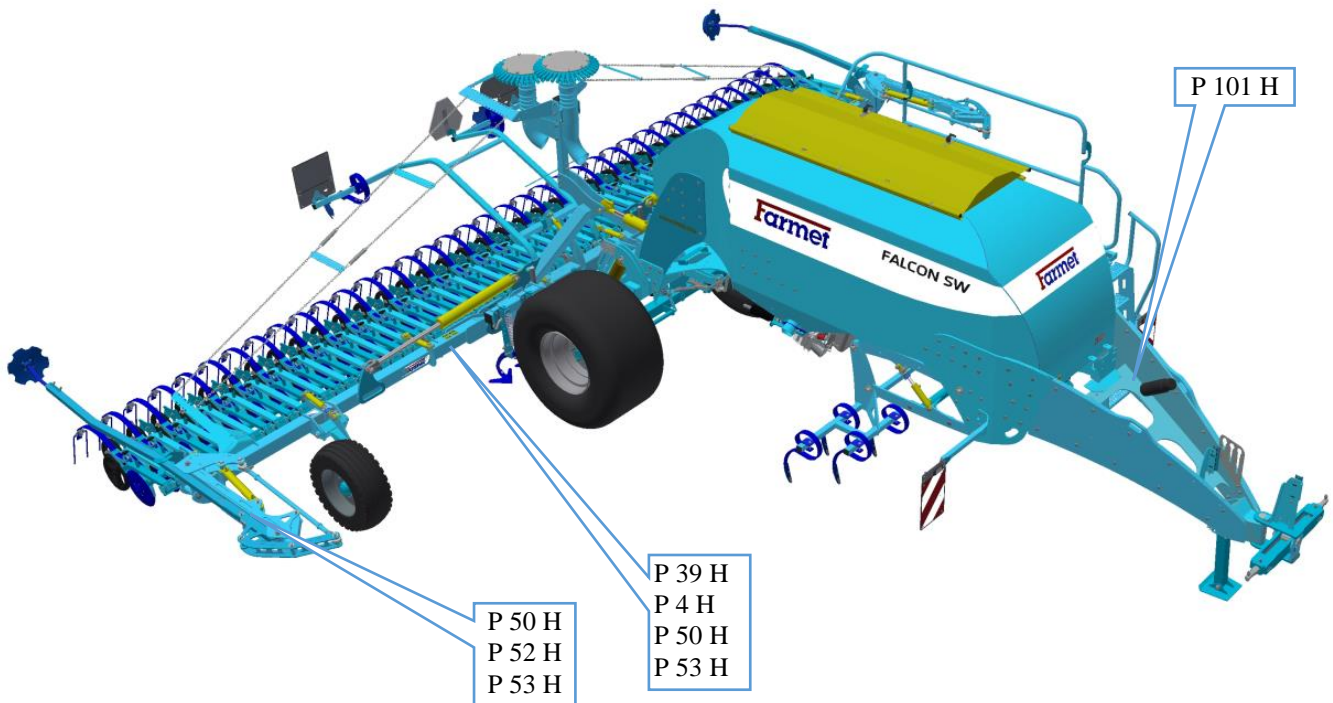

1. DESCRIPTION OF THE MACHINE

The **FALCON SW** disc sowing machine is designed as semi-carried and folding. It is connected to the tractor using a drawbar with pins of Cat III in the bottom arms of the tractor three-point suspension (TPS). In the front, there is a preparatory section for soil processing and levelling larger unevenness followed by a pneumatic-tyred ramming roller that levels and compacts soil in front of the sowing bodies. Then there is a leveller installed in the axis of each sowing body. At the end there are sowing bodies with compacting wheels and a leveller. Some of the tyres of the roller are also used for transport in the transport position. The seed container is equipped by a sowing mechanism commonly used in the standard ACCORD pneumatic sowing machines. The seeds are carried by air flow through seed tubes to the sowing body where it is placed in the soil in rows. The soil is then compacted by the wheel and levelled out with the leveller. The seeding mechanism is driven by electric motors. The fan for the transport of seeds is driven by hydraulic motor from the hydraulic circuit of the tractor. The machine is equipped with central markers and markers of rail lines. The electronic system of the machine allows checking the functions of the machine, regulation of the sowing batch and formation of rail lines. The transport wheels may be equipped with pneumatic brakes or hydraulic brakes.

WORKING PARTS OF THE MACHINE

Picture 3 – Working parts of the machine

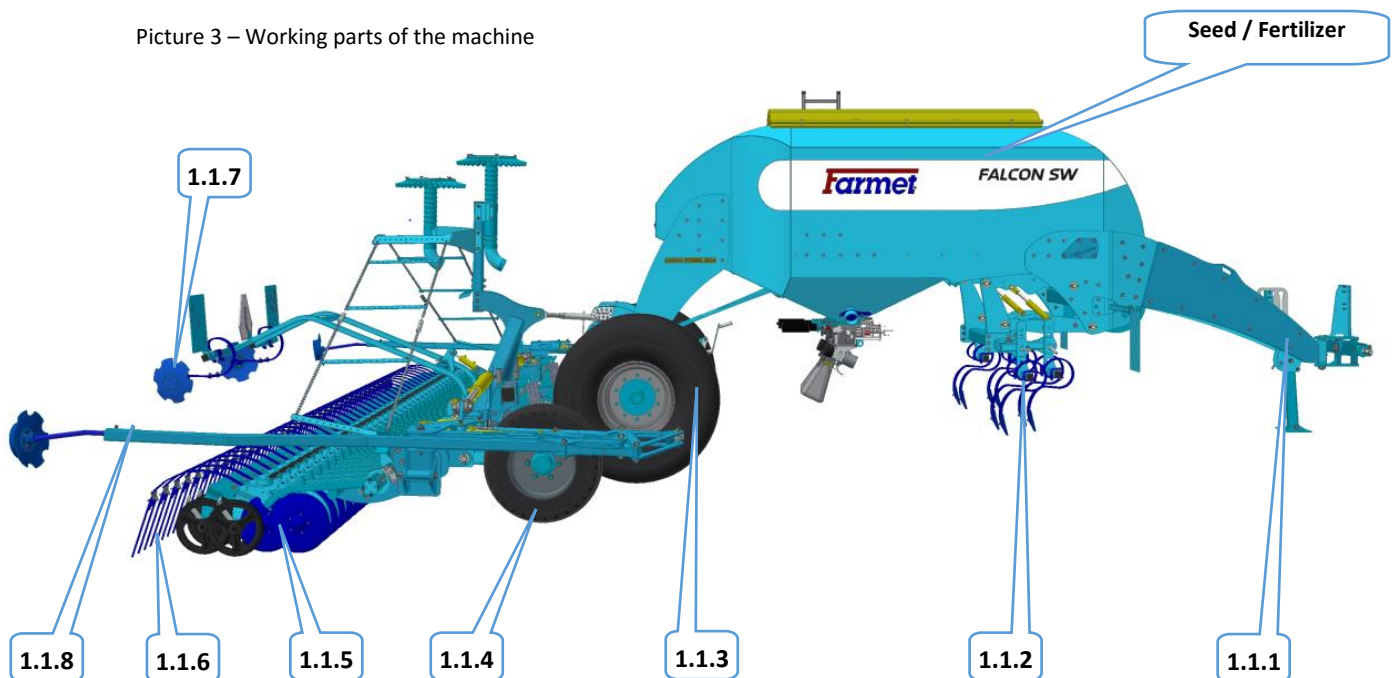

- | | | | |
|-------|--|-------|----------------------------------|
| 1.1.1 | Drawbar with a collapsible resting leg | 1.1.5 | Sowing bodies with press-wheels |
| 1.1.2 | Front section | 1.1.6 | Leveller after the sowing bodies |
| 1.1.3 | Travelling wheels | 1.1.7 | Pre-emergent rail line marking |
| 1.1.4 | Tracing wheels | 1.1.8 | Markers |

2. ASSEMBLY OF THE MACHINE AT THE CUSTOMER'S SITE



- The owner must execute the assembly according to the producer's instructions, if possible in cooperation with a professional service technician determined by the producer.
- The owner must execute a functional test of all assembled parts after the completion of the assembly of the machine.
- The owner must ensure that the manipulation with the machine by lifting equipment corresponds with Chapter "C".

3. PUTTING INTO OPERATION



- Before you take over the machine, test and check it for any damages incurred during transportation and check that all parts included in the delivery note have been delivered.
- Before you put the machine into operation, read the operating manual carefully, particularly chapters **A-D** p.6-10. Learn about the control elements of the machine and its overall function before the first use.
- When working with the machine, observe the instructions in the manual as well as generally valid rules for the safety at work, protection of health, fire and traffic safety and protection of environment.
- The operator must check the machine before every use (putting into operation) for aspects in the field of completeness, safety at work, work hygiene, fire safety, traffic safety and protection of environment. If the machine shows signs of damage, it must not be put into operation.
- Execute aggregation of the machine with the tractor on an even and compact surface.
- When working on slopes, observe the lowest allowable slope accessibility of the whole set **TRACTOR – MACHINE**.
- Before turning on the engine of the tractor, check that there are no people or animals in the working area of the set and press the warning sound signal.
- The operator is responsible for safety and for all damages caused by the operation of the tractor and the attached machine.
- The operator must observe technical and safety regulations of the machine determined by the producer when working with the machine.
- The operator must lift the machine when turning at the plough turning end, i.e. the working parts must not be in the ground.
- The operator must observe the prescribed working depths and speeds set in the instructions for use in Tab. 9/p.47 when working with the machine.
- The operator must lower the machine to the ground and secure the set against movement before leaving the cabin of the tractor.

3.1. AGGREGATION TO THE TRACTOR

- Stroj může být připojen pouze k traktoru, jehož pohotovostní hmotnost je shodná nebo vyšší než celková. The machine may only be connected to a tractor whose standby weight equals or is higher than the total weight of the attached machine.
- The operator must observe all generally valid regulations for the safety at work, protection of health, fire safety and protection of environment.
- The operator may only attach the machine to a tractor which is equipped with a rear three-point suspension (TPS) and a functional undamaged hydraulic system.
- The table with the requirements for the tractive instrument for work with the machine:

Tab.3

⁽⁵⁾ Requirement for the engine power of the tractor for FALCON SW		161 - 216 kW*
⁽⁶⁾ Requirement for TPS of the tractor	⁽⁷⁾ distance of the bottom suspension hinges (at the axes of the hinges)	1010±1,5 mm, (can be also set to 910±1,5 mm)
	⁽⁸⁾ ∅ holes of the bottom suspension joints for the suspension hinge pins of the machine	∅37,5 mm
⁽⁹⁾ Requirement for the hydraulic system of the tractor	^(x) circuit of the electric distributor	⁽¹⁴⁾ Pressure in the circuit min.190 bar – max.230 60 l/min., 2 sockets for snap coupling ISO 12.5
	⁽¹⁹⁾ circuit of the hydraulic engine	⁽²⁰⁾ Pressure in the filling branch min.130 bar–max.230 bar, 1 socket for snap coupling ISO 12.5
		⁽²¹⁾ Pressure in the waste branch max.3 bar, 1 socket for snap coupling ISO 20
	^(x) down-pressure of the sowing bodies	⁽¹⁴⁾ Pressure in the circuit min.190 bar – max.230 10 l/min., 1 sockets for snap coupling ISO 12.5
	^(x) circuit of lifting and lowering the preparatory section	⁽¹⁴⁾ Pressure in the circuit min.190 bar – max.230 40 l/min., 2 sockets for snap coupling ISO 12.5
⁽¹²⁾ Requirement for the air system of the tractor (if the machine is equipped with brakes)	⁽¹³⁾ circuit of braking of the machine axle	⁽¹⁶⁾ Pressure in the circuit min.6 bar – max. 15 bar, 1 clutch head for single circuit brakes
^(x) Requirement for the electric system of the tractor *	^(x) connection of the electronic system of the machine	12V / 40 A
		+ red - black

- Connect the machine with the carrier bar TPS to the lower arm of the tractor TPS and secure the TPS arms with pegs against disconnection.



When connecting the machine, there must not be any people in the area between the machine and the tractor.

3.2. CONNECTING THE HYDRAULICS

- Connect the hydraulics only if the hydraulic circuits of the machine and the tractor (aggregate) are without any pressure.
- The hydraulic system is under great pressure. Check regularly for leakages and immediately eliminate any visible damage to all distribution, tubes and screw joints.
- When checking for and eliminating leakages, use appropriate equipment.
- Use the plug (on the machine) and the socket (on the tractor) of the same type of snap coupling when connecting the hydraulic system of the machine to the tractor. Execute the connection of the snap coupling of the machine to the hydraulic circuits of the tractor according to Tab. 4.

Tab. 4 - Connection of the hydraulic circuits and setting up the flow of oil

Circuit	Plug	Cover colour	Oil flow direction	Flow of oil
Hydraulic motor of the fan	ISO 12,5	red	pressure tube	20 – 40 l/min
	ISO 20	black	open waste	
Controls of the machine hydraulics	ISO 12,5	blue	pressure tube	50 – 60 l/min
	ISO 12,5	blue	reverse tube	
Drill coulter pressure / Flexi boards	ISO 12,5	green	pressure tube	10 – 15 l/min
Micro drill	ISO 12,5	red	pressure tube	15 – 20 l/min
Three-point suspension	ISO 12,5	white	pressure tube	15 – 20 l/min
	ISO 12,5	white	reverse tube	15 – 20 l/min
Hydraulic drift drive / Hydraulic drive for wide-row sowing	ISO 12,5	black	pressure tube	10 – 15 l/min
	ISO 12,5	black	reverse tube	10 – 15 l/min
Lifting the front section	ISO 12,5	yellow	pressure tube	20 – 40 l/min
	ISO 12,5	yellow	reverse tube	



In order to rule out unintentional movement of the hydraulics or movement caused by third persons (children, passengers), the controlling distributors in the tractor must be secured or blocked and the controlling unit switched off if the machine is not used or if it is in the transport position.



The parts of the hydraulic system of the machine that are under pressure must not be disassembled. The hydraulic oil causes serious injuries when it penetrates the skin under the high pressure. In case of injury, immediately seek a doctor.

3.3. CONNECTING THE ELECTRONIC UNIT

- Connect the electronic unit of the machine only when the tractor is standing still and is secured against movement and intervention by third persons.
- Put the display unit to a place in the tractor where it will not obstruct the driver's view and where it will be in the visual field of the operator.
- To connect the electronic unit, use the feeding cable that is included in the machine delivery.
- The connecting cable must be connected directly to the tractor accumulator!
- The connecting cable contains the required sockets for connecting the electronic unit.
- Do not connect the connecting cable and the unit to any other connectors in the tractor.

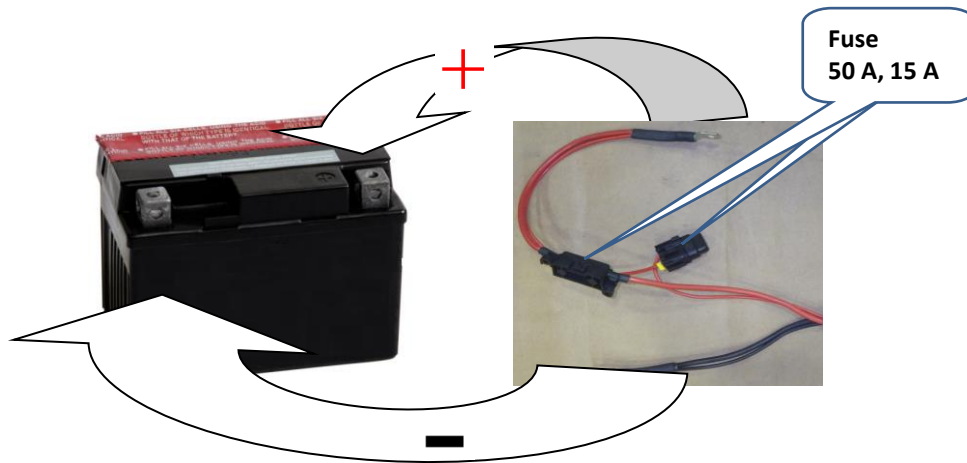

ATTENTION! Check correct polarity of the cable!

Picture. 4 - Connection socket on the tractor



3.4. MANIPULATING THE MACHINE FROM A TRUCK

If the machine is transported to the customer in a complete state, it is pulled from the semi-trailer with the use of a tractor according to the following procedure:



1. **ATTENTION!!!** Before any manipulation from the semi-trailer, the operator must make sure that there is nobody near the semi-trailer!
2. Reverse the tractor to the semi-trailer and connect the machine to the arms of the tractor and the snap coupling of the hydraulics according to chapters 3.1 and 3.2. The machine is placed on the pole on the semi-trailer and it needs to be lifted to the transportation position.
3. Subsequently, you can remove the machine from the semi-trailer with increased attention and put it aside. Place the machine on a flat ground, lifted on the axle and supported by the resting leg. Secure the wheels of the axle against movement.

3.5. CONNECTING THE HYDRAULIC MOTOR OF THE FAN

3.5.1 Description of the function

The hydraulic fan is powered directly from the tractor's hydraulic system.

For proper operation, the hydraulic pump of the tractor must supply sufficient amount of oil so that the fan revolutions are not affected by decreased number of revolutions of the tractor engine or by another hydraulic circle being switched on.

The fan revolutions are set by regulating the oil flow rate. To change the fan revolutions, the tractor must be equipped with regulation of the oil flow rate.

Picture. 5 – Hydraulic drive

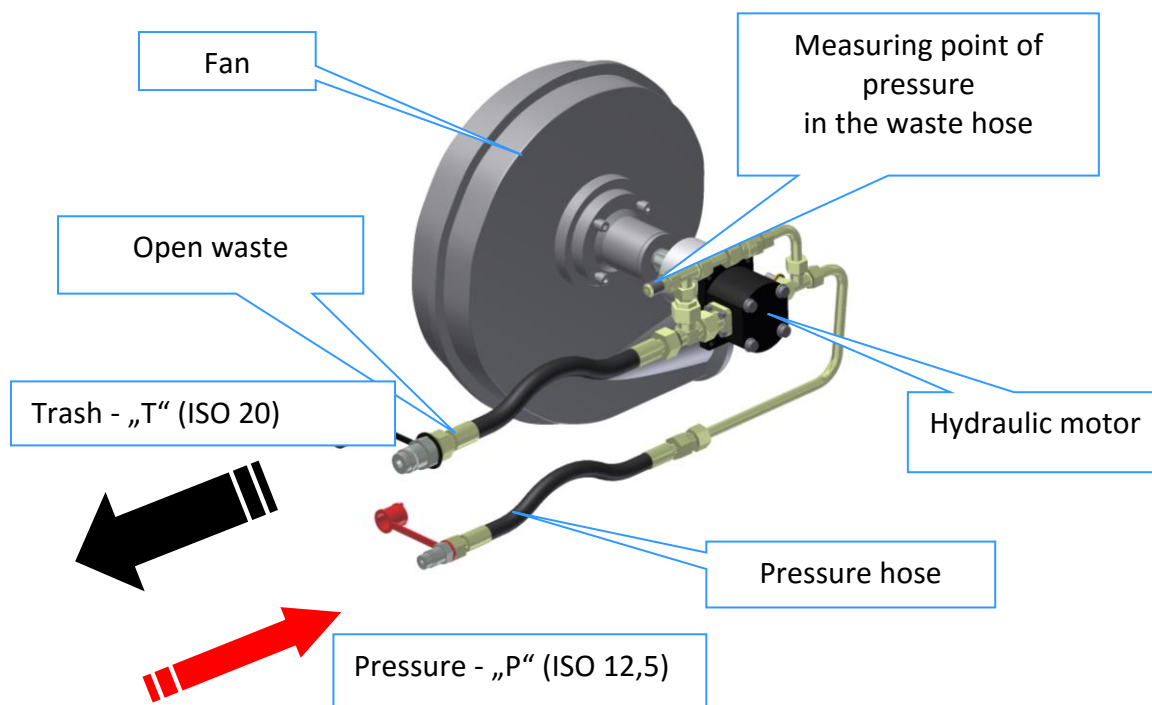

Tab. 5

Rotary hydraulic motor	Capacity (cm ³ /rev.)	8
	Minimum revolutions (rpm)	1000
	Maximum revolutions (rpm)	5000
Pressure oil - „P“	Minimum pressure in the "PRESSURE HOSE" (bar)	130
	Maximum flow rate in the "PRESSURE HOSE" (l/min.)	40
Outlet - „T“	Maximum pressure in the "PRESSURE HOSE" (bar)	5

3.5.2 Proper connection to the tractor



For proper connection, the following facts must be observed:

Outlet hose

- Do not connect the outlet hose to the tractor distributor! (pressure in the reverse branch would thus be increased)
- Large quick coupling on the outlet hose must not be confused with the small one
- Oil returning through the outlet pipe must not be throttled anywhere

- **Maximum allowed pressure value in the outlet hose is 5 bar**, higher pressure pushes the shaft seal out, which causes damage to the hydraulic motor fan

Pressure hose

- Connect the pressure hose to the circuit giving priority to the oil supply

Picture. 6 – Position of quick couplings in the tractor



1. Connecting the outlet hose

Connect the outlet hose (outer \varnothing 27 mm) with the large quick coupling to the free drain to the tractor tank.



In case that there is no free drain to the tank attached to the tractor as standard, please contact the tractor manufacturer (dealer) for information regarding the possibilities of a free drain end piece.

Picture 7 – Outlet hose connection

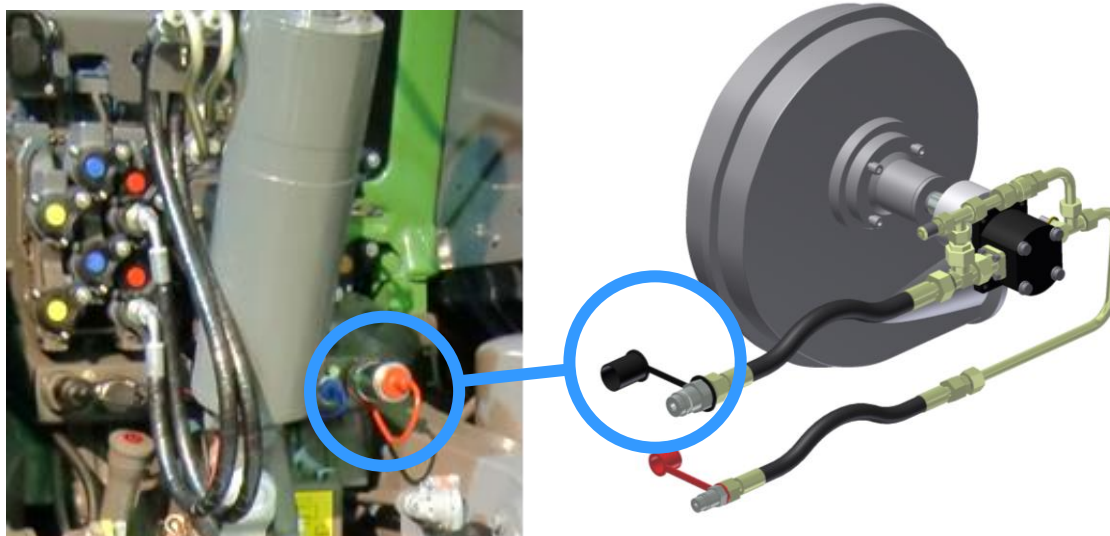

2. Connecting the pressure hose

Connect the pressure hose (outer \varnothing 22 mm) with the small quick coupling to the tractor distributor.
Connect this hose to the circuit giving priority to the oil supply.

Picture 8 – Pressure hose connection

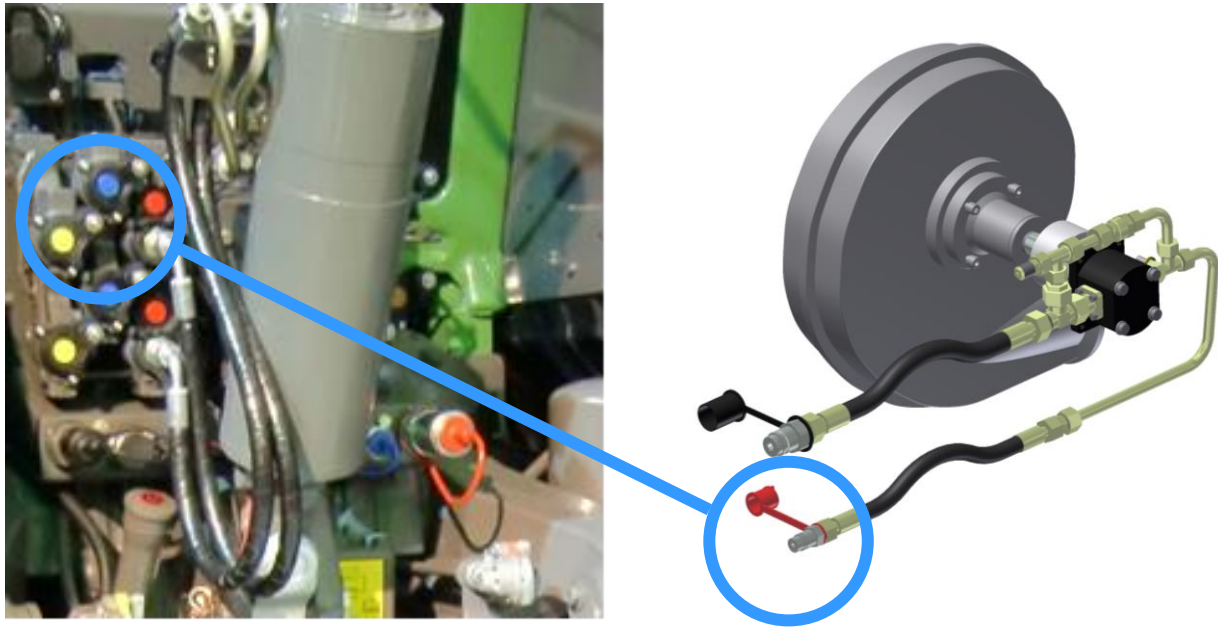

3.5.3 Commissioning

- When setting the required fan revolutions, the hydraulic oil must be warmed up.
- When commissioning the hydraulic drive, the fan revolutions (working air pressure on the pressure gauge in the hopper) must be set gradually.
- Fan revolutions (pressure on the pressure gauge) are set by regulating the oil flow rate in the tractor.
- If the hydraulic drive is started with cold oil, it is necessary to increase the motor revolutions gradually before the oil warms up.
- During commissioning and the first handover, the technician in charge of the handover must inspect all connections of the hydraulic drive and measure pressure in the outlet hose. He must record the obtained results in the handover protocol.

Picture. 9 - Diagram of the hydraulic drive of the fan

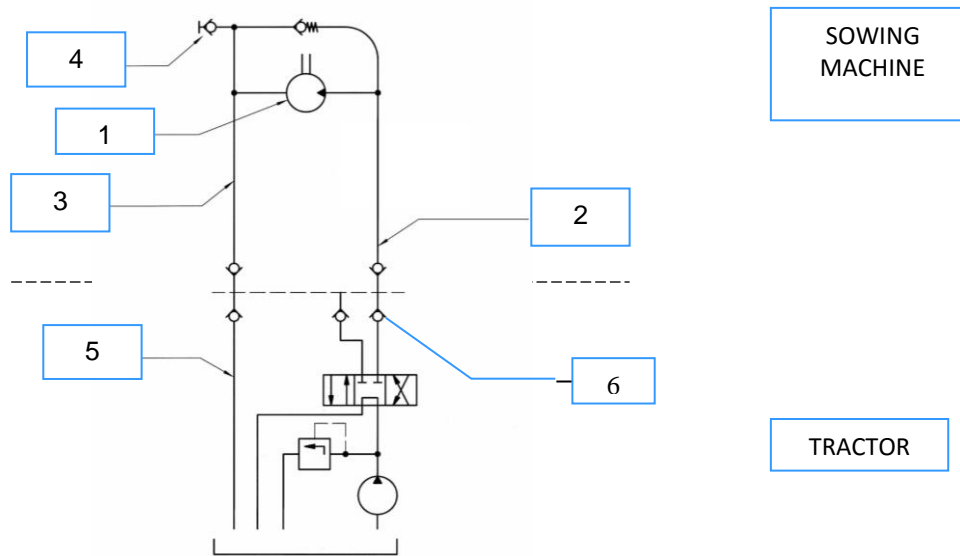

- | | |
|--------------------|-----------------------------------|
| 1. Hydraulic motor | 4. Measuring point |
| 2. Pressure hose | 5. Free drain to the tractor tank |
| 3. Outlet hose | 6. Tractor distributor |

Warning!



Farmet a.s. is not liable for any damage of the hydraulic drive or the tractor caused by improper connection of the hydraulic drive.

4. ELECTRONIC SYSTEM OF THE MACHINE

General Instructions for Use:

- Install the feeding cable (included in the delivery) in the tractor system prior to the connection of the electronic system
- The cable must be connected directly to the tractor accumulator
- The connection of the cable to the accumulator must be fixed and with a good contact – otherwise there may be system failures and improper function
- The cable must not be connected to any other connectors of the tractor!
- Pay attention to proper poling (**black -**, **red +**)
- The cable is equipped with two circuit breakers – 50A, 15A
- Use only the delivered cable to connect the electronic system
- The voltage in the accumulator must be within the range from **12 V** to **14.4 V** to ensure proper function of the system
- Secure the connecting cables between the machine and tractor against mechanical damage and against heat stress from the hot parts of the tractor and hydraulic conduction
- Turn on the display after you have connected the system to the power source
- If an unusual situation occurs during the operation, disconnect the whole system from the power source for a short time
- Only connect and disconnect all the modules of the control system when the system is disconnected from the power supply
- Turn on the system after you have started the tractor motor (do not start the motor with the system on)
- If the current fuse blows, first find the cause of the defect or seek professional service
- Do not replace the current fuse with another item
- Some parts of the system may heat up to the temperature of 50°C during operation. If the temperature is higher, look for the cause or seek professional service
- Protect the display from water and temperatures below -20°C and above +60°C
- If you have to perform welding on the machine or the tractor, disconnect the unit from the power source and disconnect the connecting cables



Turning the Sowing and Off

Turning the sowing on and off is controlled by two sensors. The system is designed so that the sowing turns on at the beginning of recessing. Before the seeds go through the whole system of the pneumatic distribution, the machine has already recessed and the delay in the launch of sowing at the beginning of the patch is thus minimized. The sowing is turned off at the beginning of digging out.

TURNING ON THE SOWING

Turning on is controlled by an aerial sensor. The aerial sensor is set to turn on at the beginning of recessing. The sensitivity of the switching depends on the position of the sensor set between the axle frame and the main frame of the machine. It can be adjusted by loosening the screws (see the picture 10) and changing the position of the sensor towards the holder. Furthermore, the sensor turns on the control of the machine functions.

TURNING OFF THE SOWING

Turning the sowing off (the electric motors of the seed feeders) is controlled by a pressure sensor located in the hydraulic circuit of the axle lifting. The sensitivity of this sensor is set to the pressure of 7 MPa. When the machine is digging out, the oil pressure is led to the hydraulic distributor and when the set value is reached, the switch turns on and the motors of the seed feeders turn off.



Therefore, move the lever for the hydraulic control to the **FLOATING POSITION** after the machine has been recessed!!!

The sensitivity of the pressure and aerial sensors is standardly set by the producer. Only a professional service may change the setting.

Picture 10 – Aerial sensor

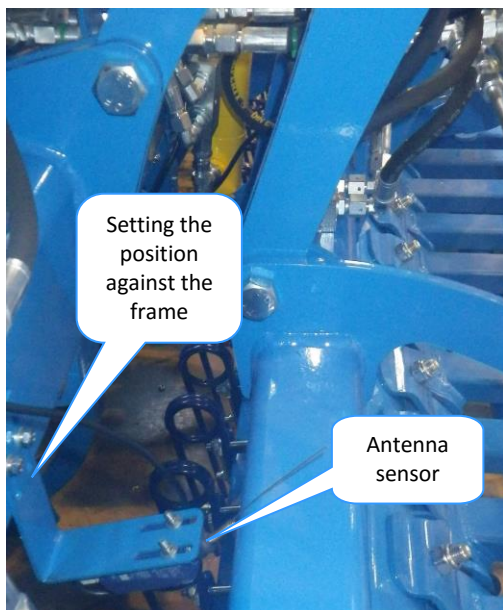

Picture 11 - Pressure sensor

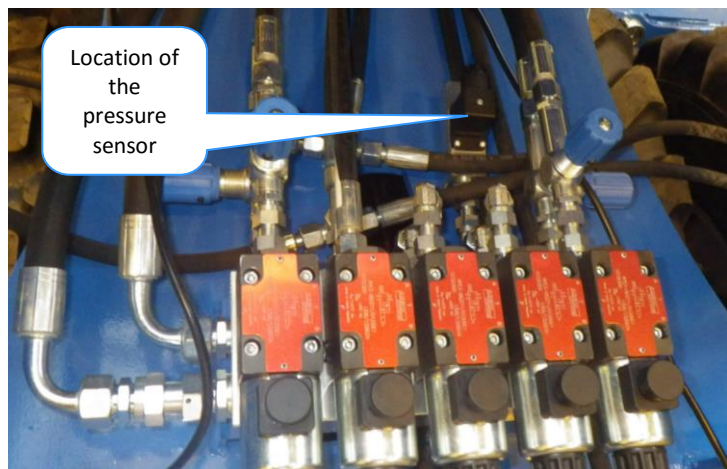

Radar

The radar provides a very exact measurement of the travel speed which is important for exact batch of seeds. Do not stay or move in the working area of the radar.

4.1. DESCRIPTION OF MACHINE CONTROL BY MÜLLER ELECTRONICS

Falcon sowing machines are equipped with the Müller electronic system. The following chapters briefly and clearly describe the basic control and description of the electronic system.

4.2. DESCRIPTION OF THE BASIC DISPLAY

The basic display of the terminal is shown in the picture below the text. The basic display provides access to all functions that are required for the work in the field. Also, the basic display shows all important data, such as speed of the machinery, ventilator revolutions, seed quantity, creation of rail lines, and the position of the rear sowing section.

Picture 12 - Description of the basic display

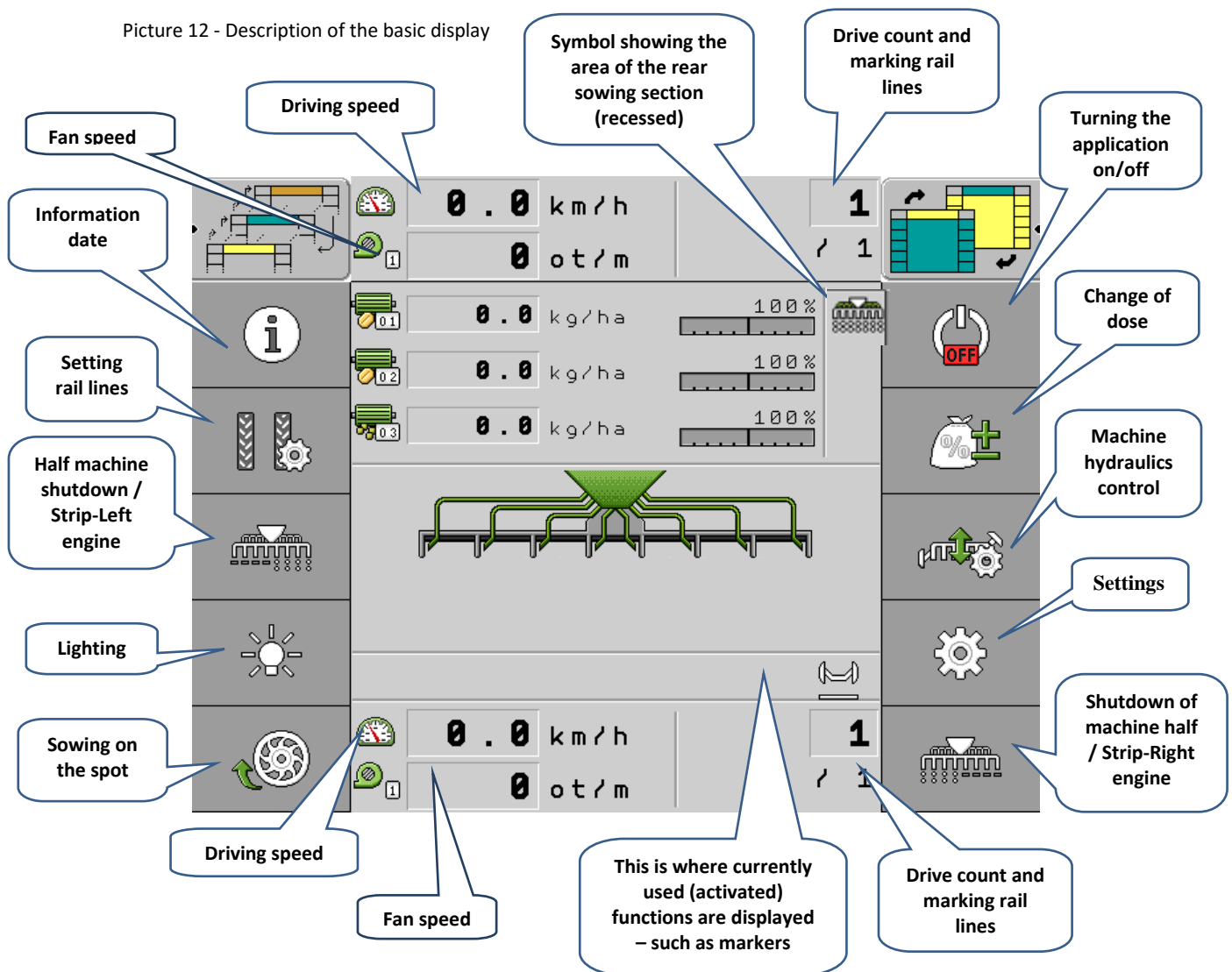

4.3. CONTROLLING HYDRAULICS

Procedure for unfolding and folding the machine

- Press the key for controlling hydraulics (A)
- Then press the key for unfolding/folding (B) and unfold the machine
- Confirm the task after the machine has unfolded (C)

Picture 13 – Procedure for folding/unfolding the machine

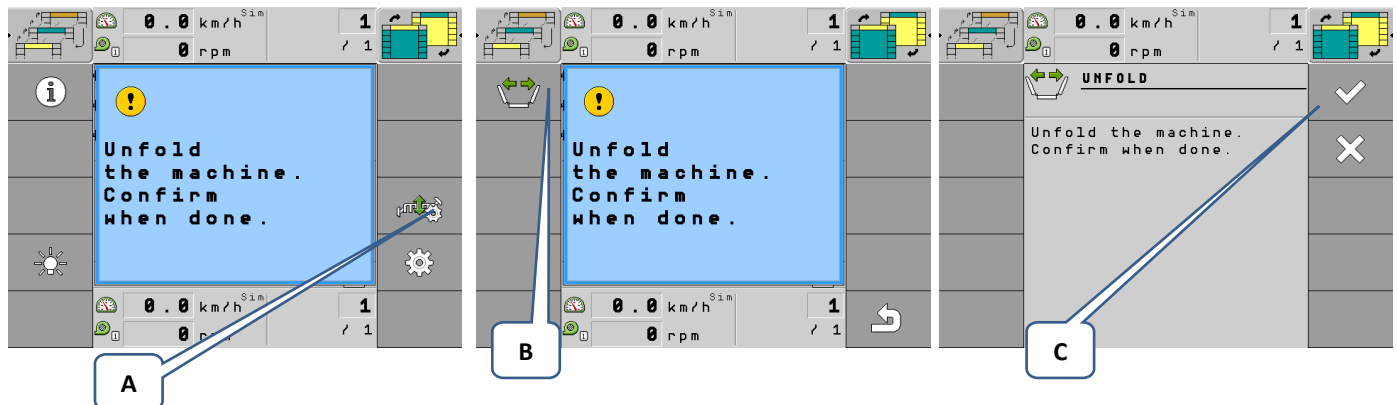

- *Controlling the rear sowing section* – controlled from the tractor using the blue hydraulic circuit when the application is activated (also possible to control when the display unit is off). Then in combination with markers.
- *Controlling the front sowing section* – controlled from the tractor using the yellow hydraulic circuit when the application is activated. For transport, it is required to close the ball valve located on the pole of the machine to prevent undesirable movement of the front section during transport.

4.3.1 Controlling markers

Markers are controlled by pressing the key for markers control as shown in the picture below. On the following screen choose which marker or function you want to activate.

If no marker is selected before the run, the machine will work without them.

Picture 14 – Controlling markers

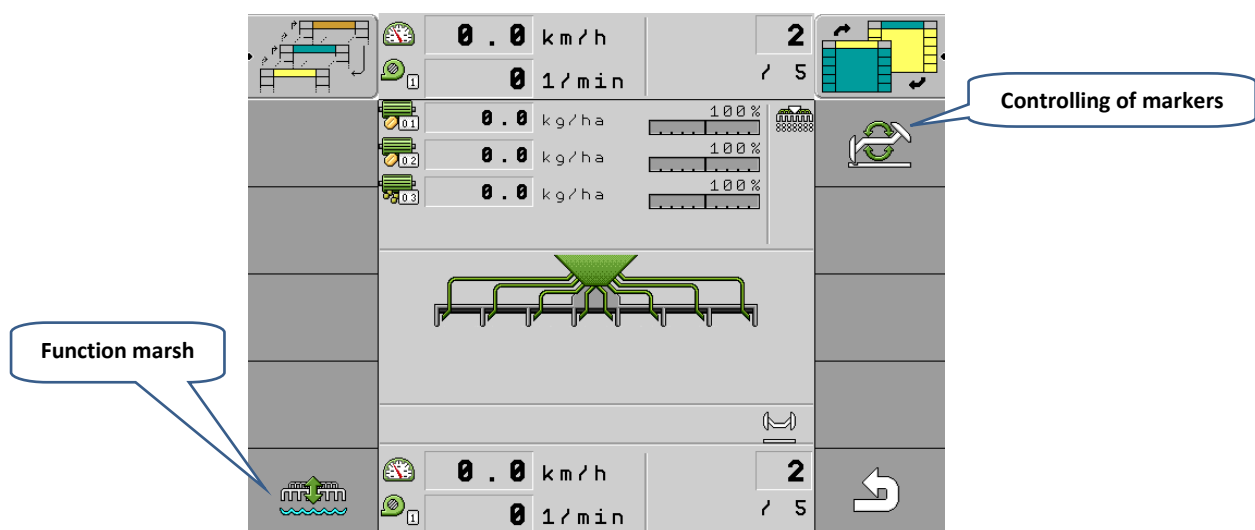

Description of markers control: an activated marker is always displayed for a moment as shown in the picture below. After a few seconds, it goes out but its symbol stays on the display (a small symbol at the bottom of the display).

Picture 15 – Description of markers control

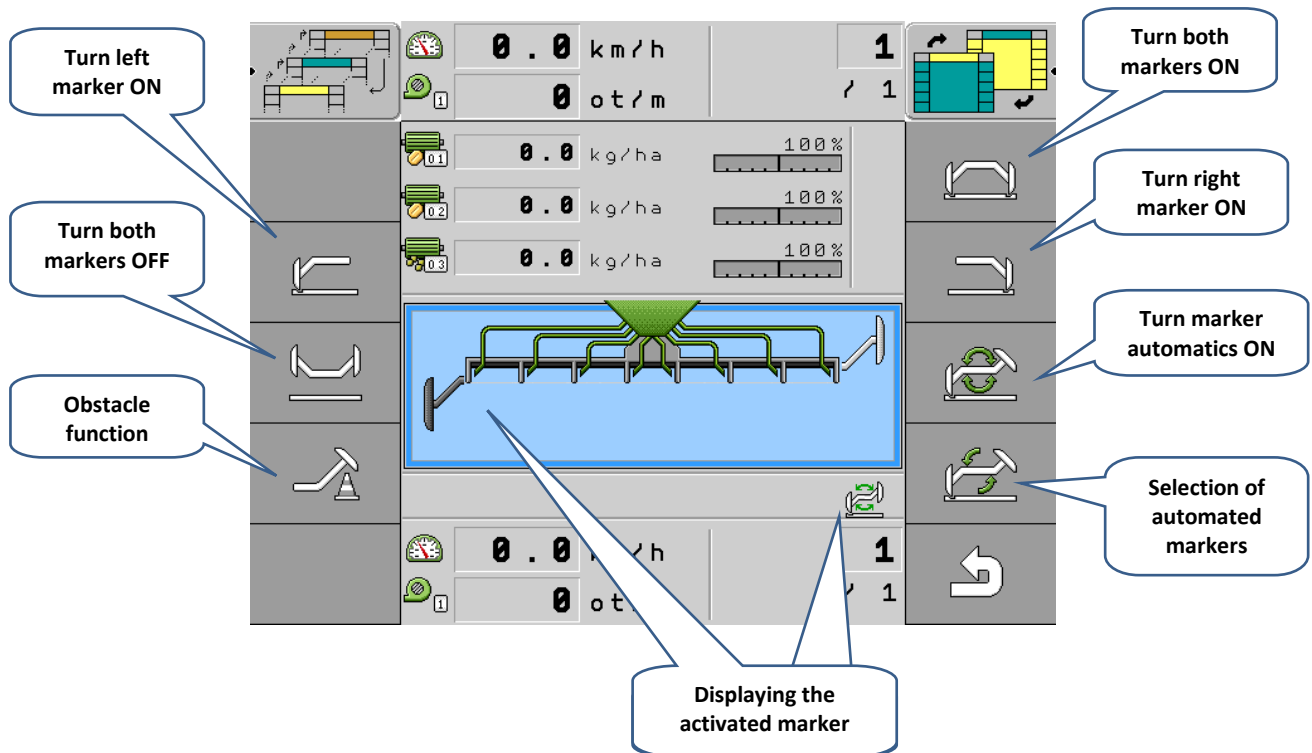

Obstacle function – used for avoiding obstacles. When this icon is activated, only the activated marker is lifted when the hydraulic circuit is pressed but the machine remains recessed and seeding. The activated element is always displayed in the right bottom corner of the display unit.

Marsh function – if it is necessary to drive through wet spots (marshes) during seeding or when the machine accidentally ends up in a marsh, then this function can be activated by pressing the corresponding hydraulic circuit that lifts the sowing section but the machine continues sowing. This increases the passage ability of the machine through wet spots.

Picture 16 – Description of functions

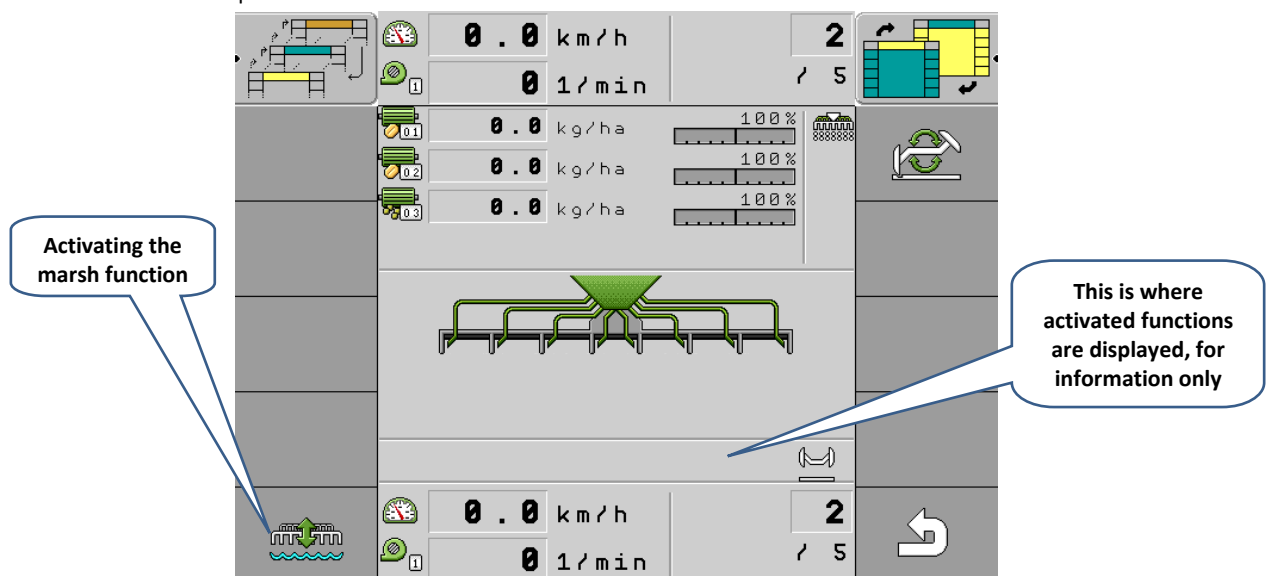

4.4. RAIL LINES SETTING SYSTEM

The Müller electronic system allows various rail lines setting.
For basic rail lines setting, you need to know where and how many rail flaps are installed and used on the machine. Graphic illustration follows.

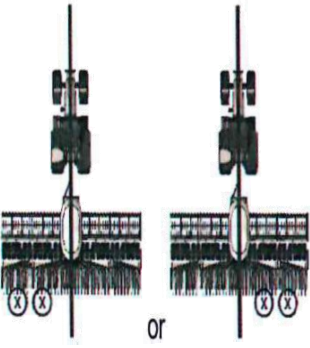
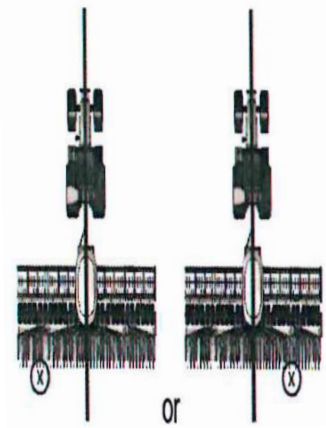
<p>A)</p> 	<ul style="list-style-type: none"> • Two rail flaps on both sides of the machine • Our most frequently used solution • This layout of rail flaps always corresponds with an odd number of passes of the seed drill per width of the sprayer • It is also possible to set the rhythm of rail lines for even number of passes of the machine, but that requires the execution of a “zero pass”
<p>B)</p> 	<ul style="list-style-type: none"> • Two rail line flaps on one side of the machine (on the right or on the left) • The location of the flaps on the right or on the left depends on which side of the field seeding starts on
<p>C)</p> 	<ul style="list-style-type: none"> • One rail line flap on one side of the machine

4.4.1 Setting rail lines rhythm

This specific setting of the rail lines is accessed via the first screen where we press the button of the relevant rail lines icon. Then press the button for rail lines setting (a symbol of rail lines with lower-case letter “n” in the right bottom corner). There you select the required configuration of the rail lines rhythm; the configuration depends on the versions (A, B, C) described above.

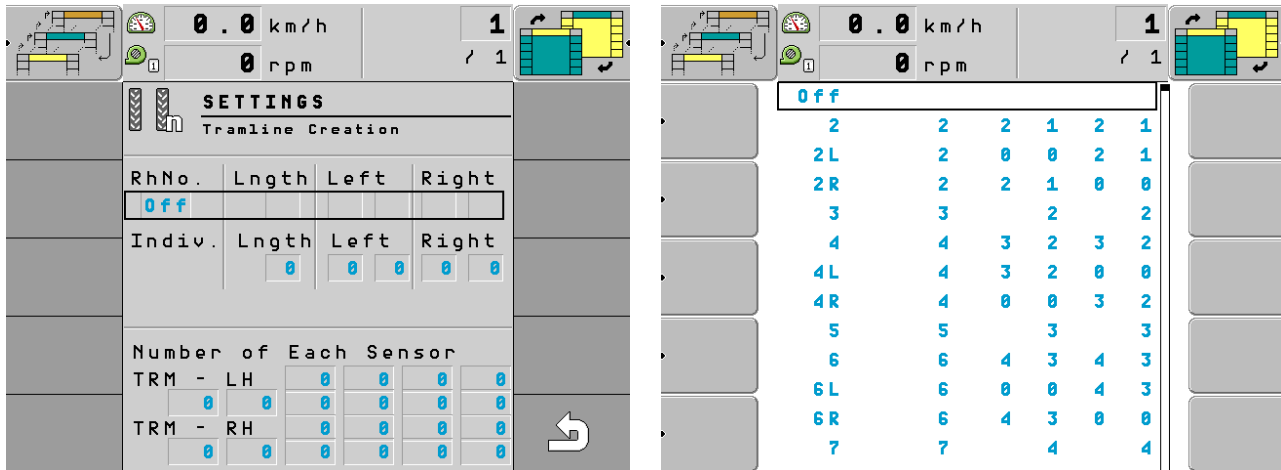

Line No.	<ul style="list-style-type: none"> Number of the rail line (number of passes of the machine per width of the sprayer)
Length	<ul style="list-style-type: none"> Number of passes that determines the rail lines rhythm repetition
Left, Right	<ul style="list-style-type: none"> Determines the pass during which a rail line is created (left, right)
Individual Setting	<ul style="list-style-type: none"> Here you can choose your own settings

Individual steps for setting the correct rail lines rhythm

1. We know the width of the machine
2. We know the width of the sprayer
3. We know the number of rail flaps on the machine and we know exactly where they are located (which side, number...)
4. We have to do a simple calculation
Structural width of the sprayer: Structural width of the machine
5. Select the rail lines rhythm on the appropriate screen based on the facts above

Version A) Rail lines are formed during one pass of the seed drill

a.

Possible flap positions	Calculation result	Line No.	Resulting rhythm	Left flaps		Right flaps	
	3	3	3		2		2
	5	5	5		3		3
	7	7	7		4		4
	9	9	9		5		5
	11	11	11		6		6

Example:

The structural width of the sprayer is 30 m, the structural width of the machine is 6 m.

Procedure: $30:6=5 \rightarrow$ Resulting rhythm – yellow line in the chart

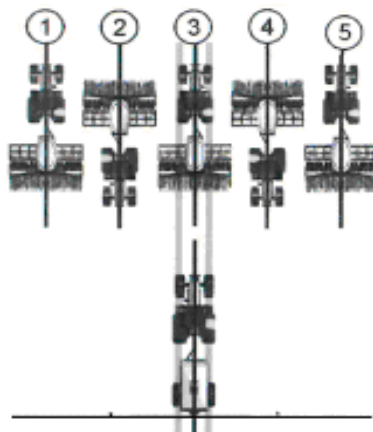

b.

Possible flap positions	Calculation result	Line No.	Resulting rhythm	Left flaps		Right flaps	
	2	2S	2		1		1
	4	4S	4		2		2
	6	6S	6		3		3
	8	8S	8		4		4
	10	10S	10		5		5

Example:

The structural width of the sprayer is 12 m, the structural width of the machine is 3 m.

Procedure: $12:3=4 \rightarrow$ Resulting rhythm – yellow line in the chart (rhythm 4S)

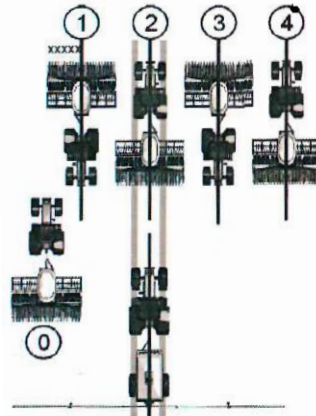

- The picture shows that the rail lines are formed during the second pass. First, a “zero” pass has to be executed during which the rail lines system must be deactivated. During the first pass, we have to sow with a half of the machine over the zero pass, or we have to turn off a half of the seed drill.

Version B) Rail lines are formed during one pass of the seed drill

Sowing starts on the left side of the field

Possible flap positions	Calculation result	Line No.	Resulting rhythm	Left flaps		Right flaps	
	2	999	2				1
	4	999	4				2
	6	999	6				3

Example:

The structural width of the sprayer is 24 m, the structural width of the machine is 6 m.

Procedure: $24:6=4 \rightarrow$ Resulting rhythm – yellow line in the chart

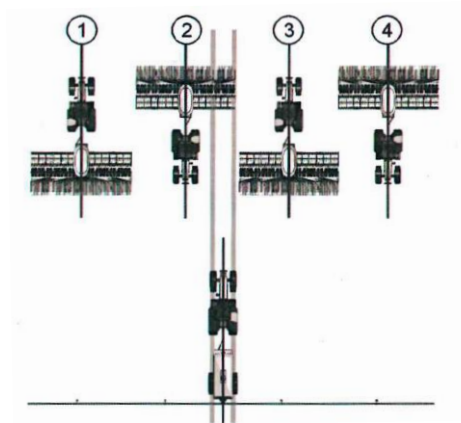

- The picture shows that the rail lines are formed during the second pass
- If the rail flaps are located on the other side of the seed bar, the procedure will be the same but sowing starts on the right side of the field and thus rail lines will be formed on the right side of the seed drill

Version C) Rail lines are formed during two passes of the seed drill

If sowing starts on the left side of the field

Possible flap positions	Calculation result	Line No.	Resulting rhythm	Left flaps		Right flaps	
	2	999	2			1	2
	4	999	4	2	3		
	6	999	6			3	4
	8	999	8	4	5		
	10	999	10			5	6
	12	999	12	6	7		
	14	999	14			7	8

Example:

The structural width of the sprayer is 12 m, the structural width of the machine is 3 m.

Procedure: $12:3=4 \rightarrow$ Resulting rhythm – yellow line in the chart

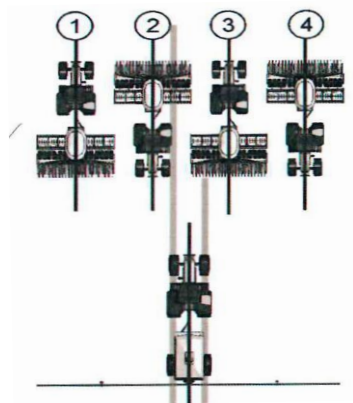

- The picture shows that rail lines are formed during the second and third pass of the seed drill
- If the rail flaps are located on the other side of the seed bar, the procedure will be the same but sowing starts on the right side of the field and thus rail lines will be formed on the right side of the seed drill

Our Most Frequently Used Rail Lines Settings

The actual setting of rail lines is performed on the rail lines setting screen. For better orientation and understanding of the rail lines setting, we provide both graphic and chart illustration. The system of setting the rhythm of the rail lines is shown both in the graphic and chart illustration.

SETTINGS
Tramline Creation

RhNo.	Lngth	Left	Right
Off			
Indiv.	Lngth	Left	Right
	0	0 0	0 0

Number of Each Sensor					
TRM - LH	0	0	0	0	0
TRM - RH	0	0	0	0	0

Setting marker flaps (left, right)

How many times a track is created

Width of the seed drill 3 m
Width of the sprayer 15 m

Width of the seed drill 6 m
Width of the sprayer 42

Width of the seed drill 4 m
Width of the sprayer 36

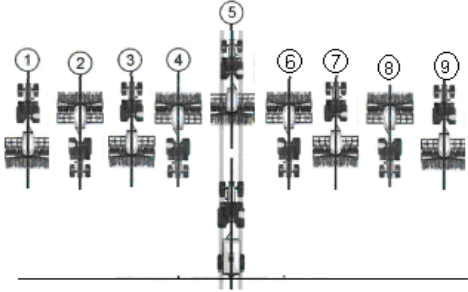
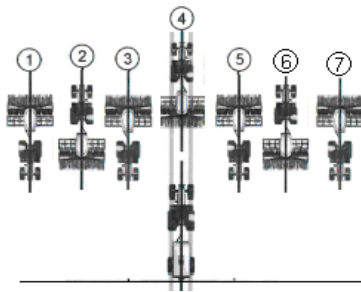
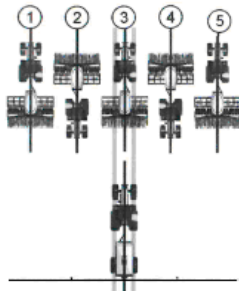

Width of the machine (m)	Width of the sprayer (m)	Program Line No.	Resulting rhythm	Left flaps	Right flaps
3	15	5	5	3	3
3	21	7	7	4	4
3	27	9	9	5	5

Width of the machine (m)	Width of the sprayer (m)	Program Line No.	Resulting rhythm	Left flaps	Right flaps
4	20	5	5	3	3
4	28	7	7	4	4
4	36	9	9	5	5

Width of the machine (m)	Width of the sprayer (m)	Program Line No.	Resulting rhythm	Left flaps	Right flaps
6	18	3	3	2	2
6	30	5	5	3	3
6	42	7	7	4	4

Width of the machine (m)	Width of the sprayer (m)	Program Line No.	Resulting rhythm	Left flaps	Right flaps
8	24	3	3	2	2
8	40	5	5	3	3

4.4.2 Setting Rail Lines

Picture 18 – Setting Rail Lines

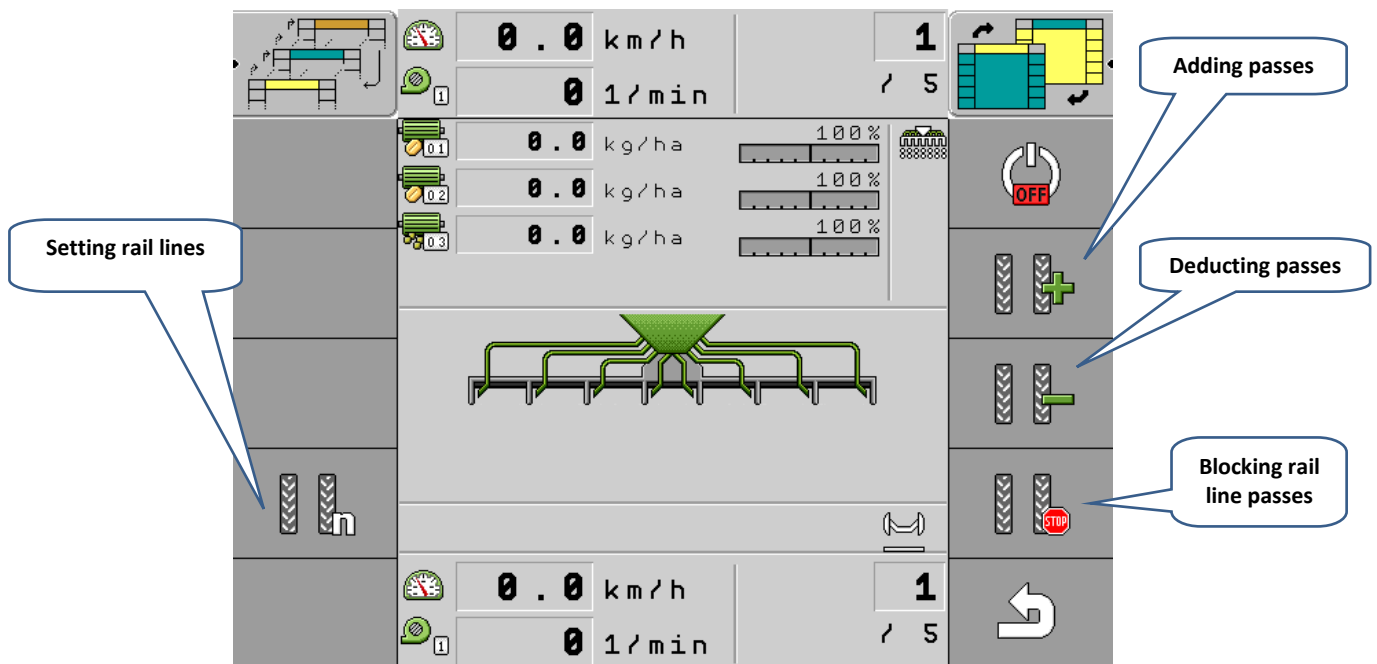

Picture 19 - Setting the rhythm of rail lines in the display unit

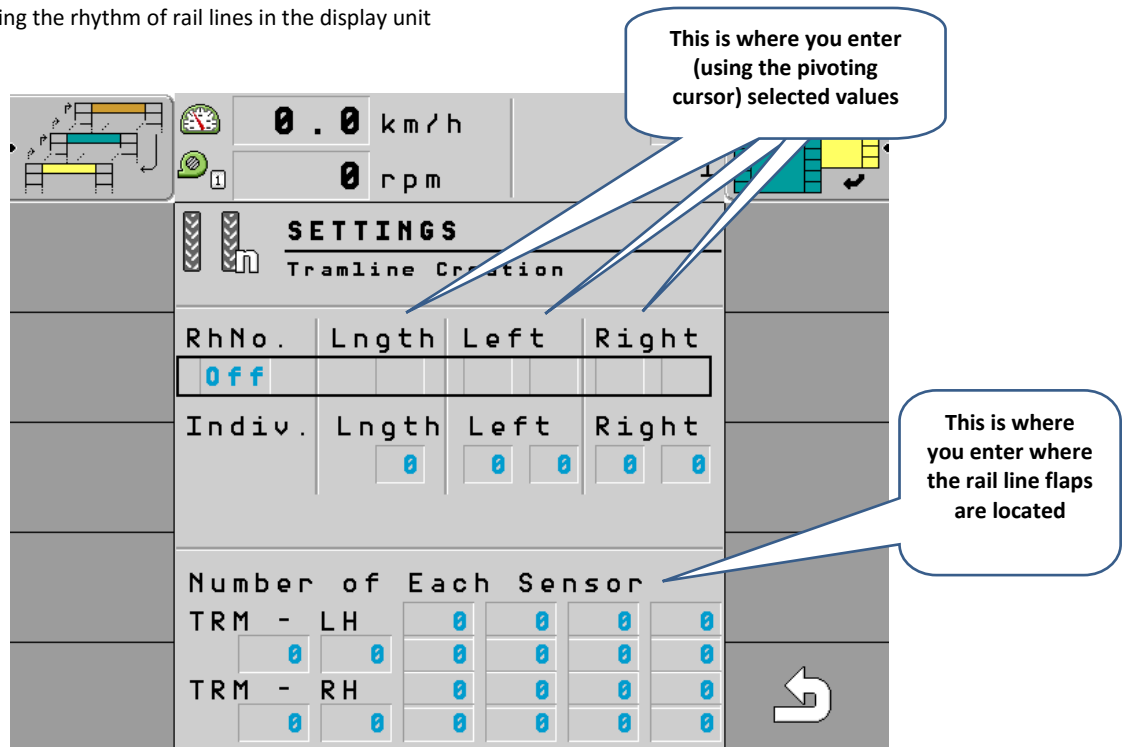

4.5. REFERENCE DATE

Picture 20 – Reference Data

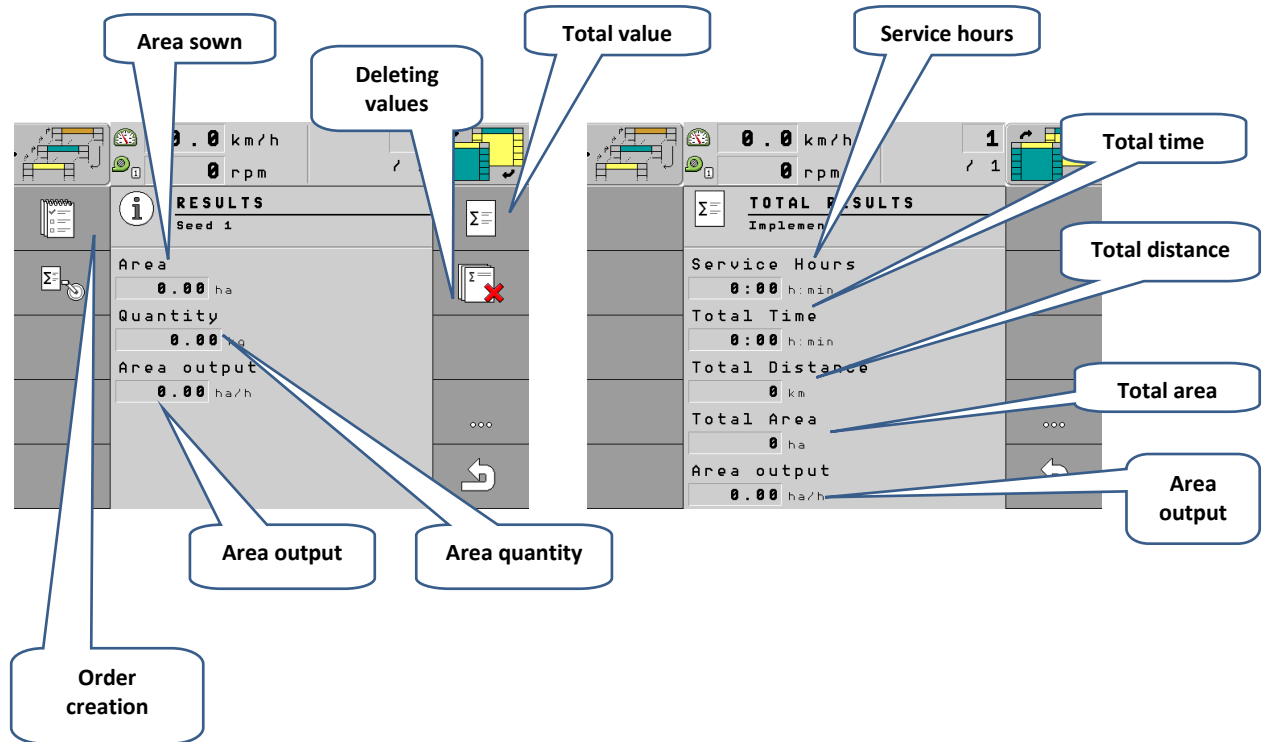

4.5.1. Creating an order

- Useful for field descriptions and customer service.

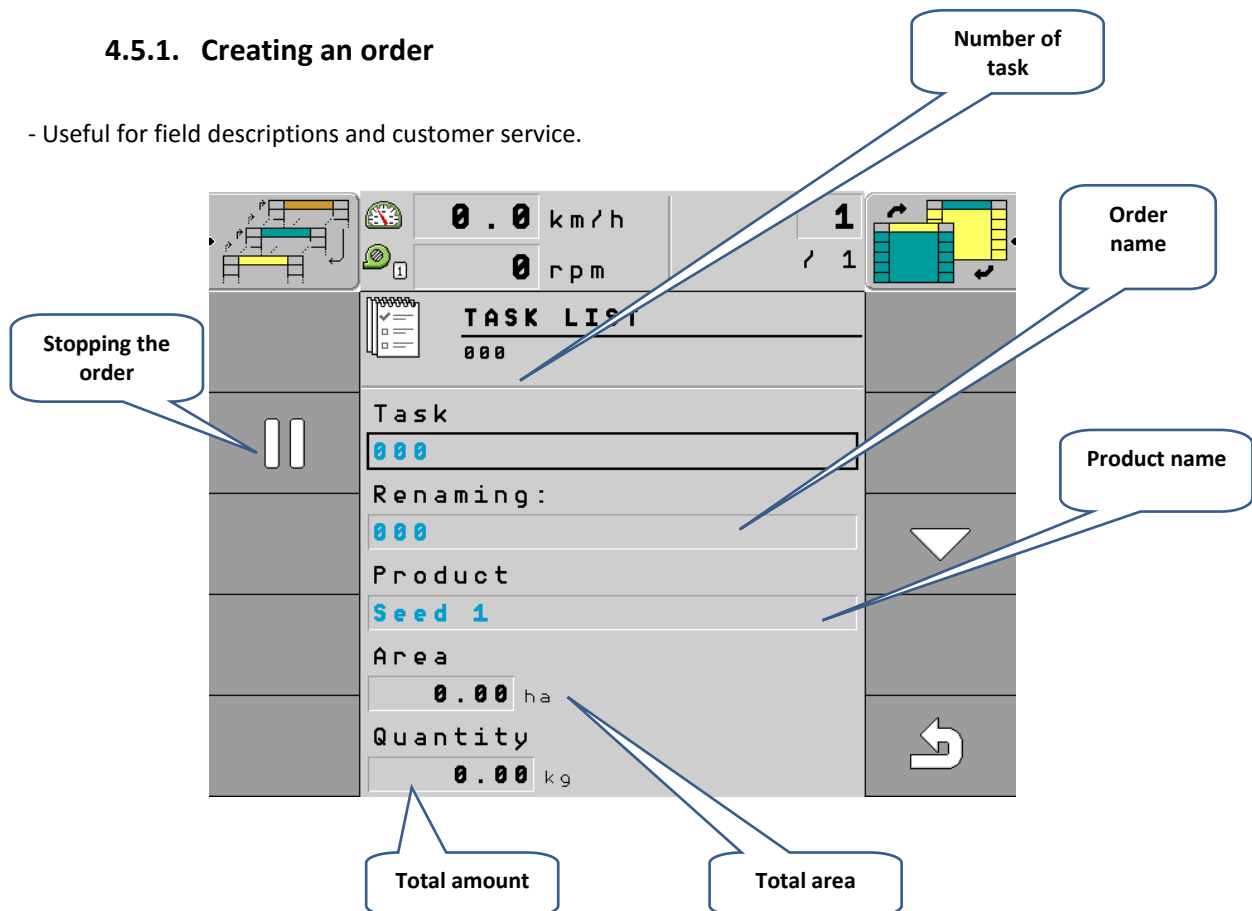

4.5.2. Level of seeds in the hopper

There is a level sensor in the hopper that shows the remaining amount of seeds. The sensor can be adjusted by height according to the type of seeds or as required by the operator. When the amount drops below the level, the sensor illuminates a red symbol on the display (top right corner). This signalization is accompanied with a warning message.

Activation/deactivation of sowing or fertilization – this button is used for activating or deactivating sowing or fertilization: the button stops the appropriate motor driving the seeding mechanism (also, sensors in the hopper are deactivated).

Picture 21 – Activation/deactivation of sowing or fertilization

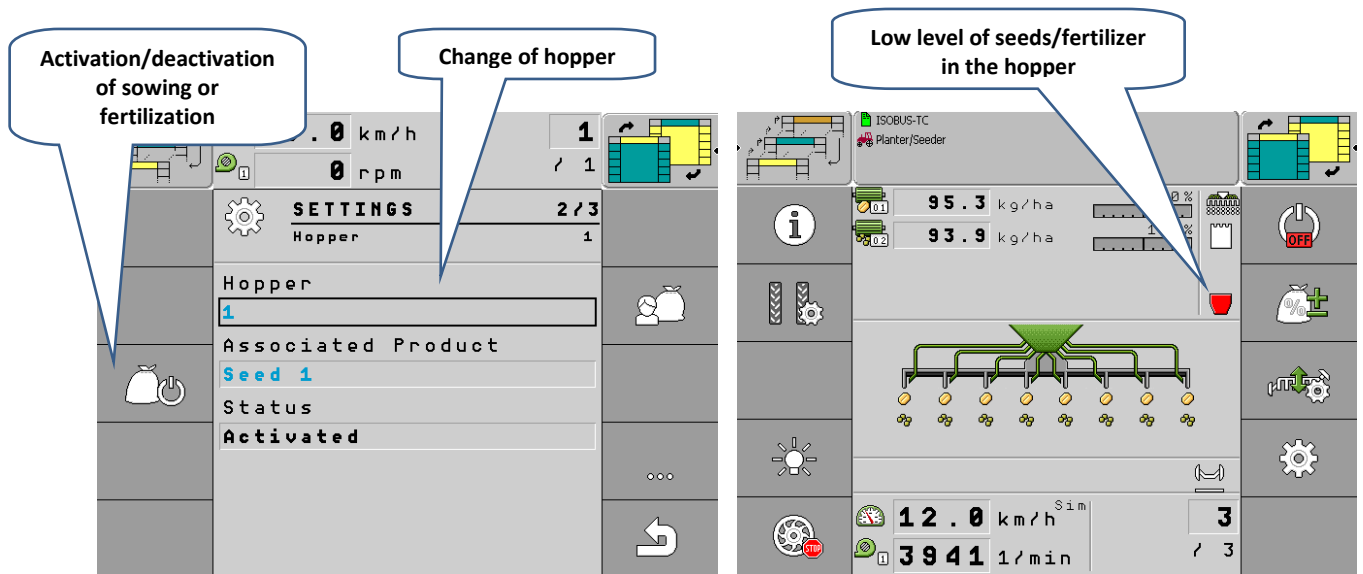

4.6. SETTING PASSAGE SENSORS

With regard to the passage sensors, the sensitivity of the setting of the individual sensors is important. Practice shows that cereals should be set at 6 and fine seeds, such as rape, should be set at 3.

If none of the sowing hoses is clogged, the status of sensors is not displayed anywhere. At the moment when one of the hoses gets clogged, an error message is displayed – a chart appears on the display showing which sensor is blocked (in which row).

Picture 22 – Setting the sowing sensors



Control value of sensors – at 10km/h

ZJ value	Type of seeds	Seed quantity per time
0		System off (no report)
1	RAPE, MUSTARD	1 seed/16s
2	RAPE, MUSTARD	1 seed/8s
3	RAPE, MUSTARD	1 seed/2s
4	WHEAT, RYE, BARLEY	1 seed/s
5	WHEAT, RYE, BARLEY, OATS	2 seed/s
6	WHEAT, RYE, BARLEY, OATS	5 seed/s
7	OATS	10 seed/s
8	OATS	20 seed/s
9		100 seed/s
10		1000 seed/s

If the defined number of seeds does not pass through during the given time, the system reports a low passage of seeds, so this is not sensitivity as such but a control parameter of the seed passage.

Picture 23 – Setting sensor sensitivity

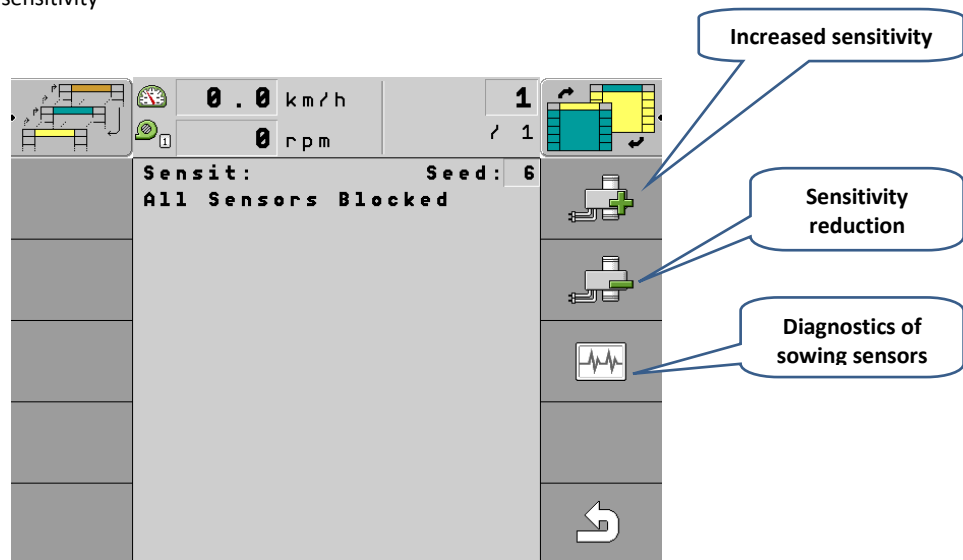

4.6.1 Seeding sensor diagnostics

This screen is used for checking the passability of the individual sowing hoses. When there are red crosses in all rows, seeds do not pass through the sensor. The passage of seeds is signalled by green ticks, i.e. when there are green ticks in all rows, all sensors are working correctly – the hoses are passable and the seeds pass through them.

The passability of seeds can also be checked during driving in the sensor diagnostics. If any of the hoses gets clogged, the passage sensor registers it and a signal in the form of a chart appears on the main screen showing which hose is blocked.

- Displaying sensor diagnostics**
- red crosses → seeds do not pass
 - green ticks → seeds pass

Picture 24 – Sensor diagnostics

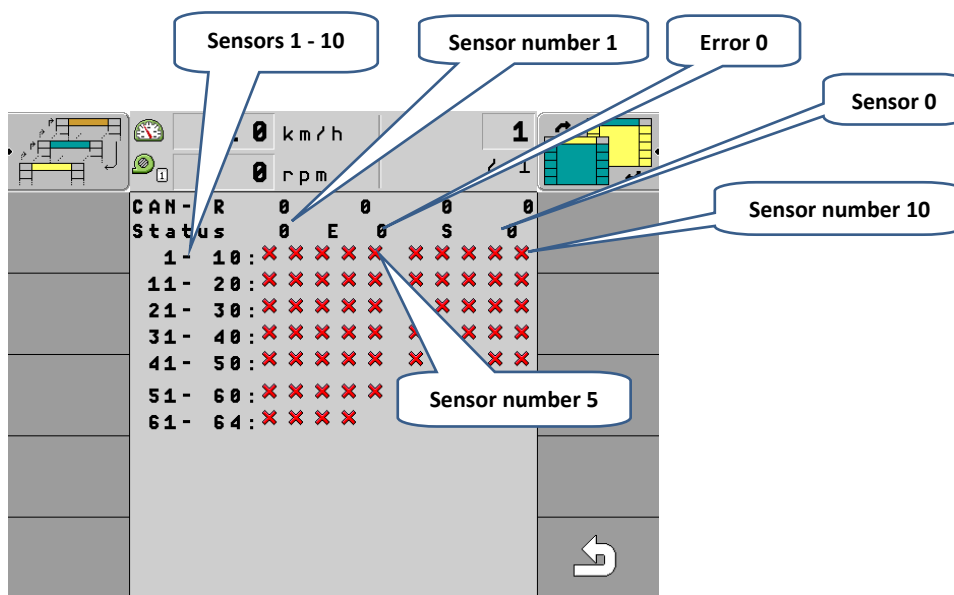

4.6.2 Switching off the seed flow system sensors

OFF/ON: when the seeding application is OFF---setting---page 3/3---Agtron/NO

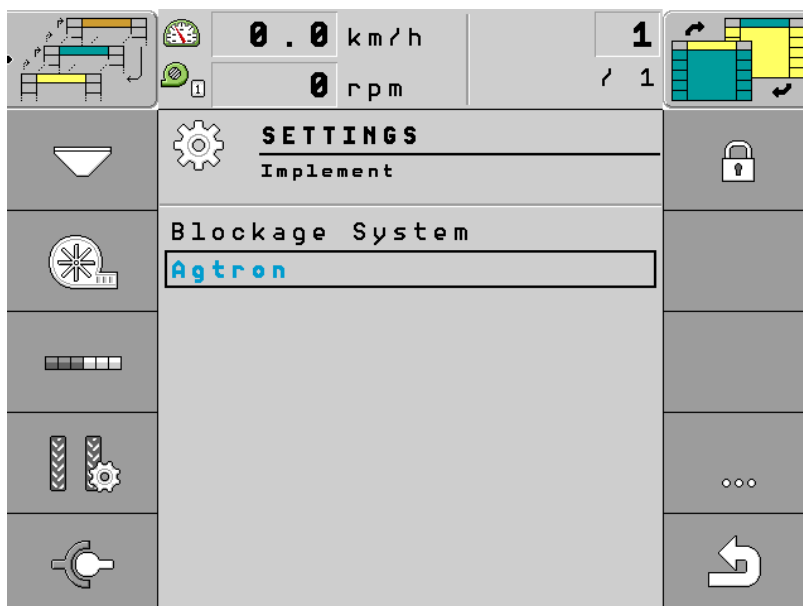

4.6.3 Designation of motors and dosers

Example for Falcon SW

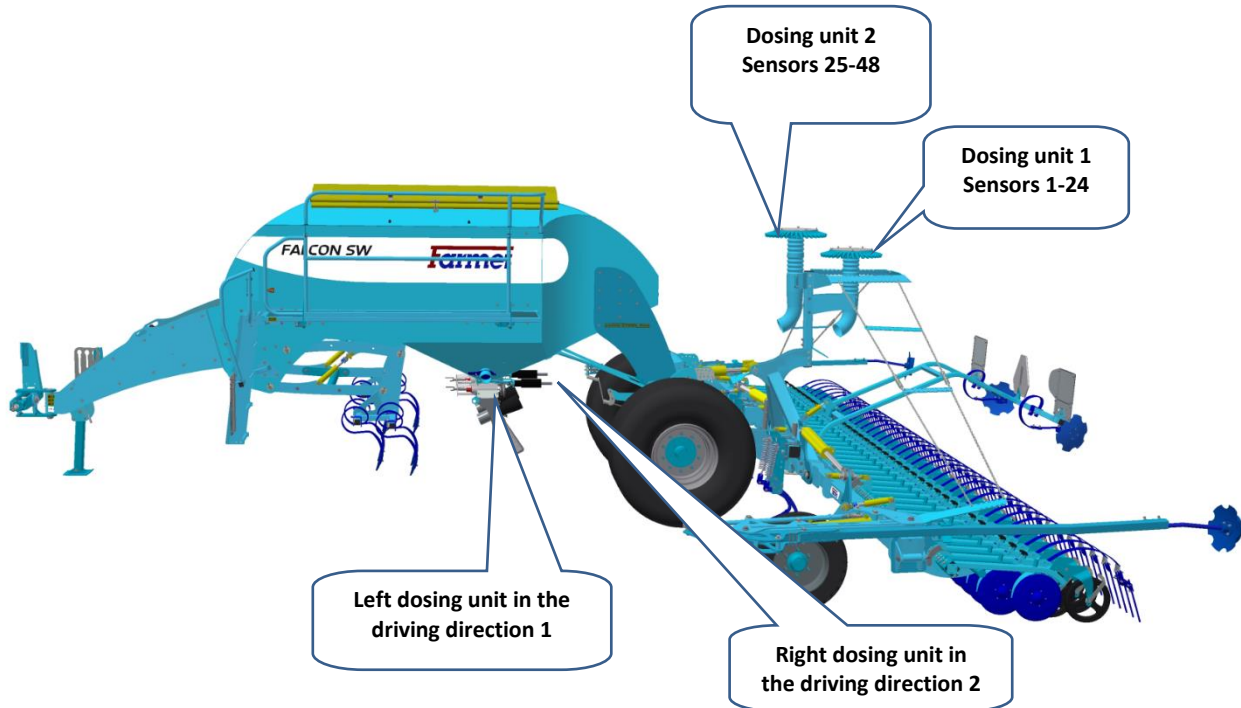

5. UNFOLDING AND FOLDING MACHINE



When executing any of the hydraulic movements, slow down the moving parts of the machine before position stop by choking a relevant valve on the tractor control!



- The hydraulics of the machine must be connected to a push-pull hydraulic circuit.
- The operator must ensure that there are no people or animals within the reach of the side frames during their unfolding or folding (i.e. in the place of their position stop) and that no one puts their fingers or other body parts into the area of the joints.
- Execute unfolding or folding on flat and solid surfaces or crosswise to a slope.
- Unfold or fold the machine only when it is lifted on the axle.
- Remove any soil stuck on the folding places as it may disturb the function and cause damage to the mechanics.
- Monitor the side frames during unfolding or folding and fold them smoothly until the end position.

5.1. UNFOLDING THE MACHINE



1. Prior to unfolding, it is necessary to unblock the mechanical protection of the side frames on the front preparatory section. The protection is provided by pins in the front joints of the folding mechanism. There is one pin on each side.
2. Press the key for machine hydraulics control (A) on the display unit screen, then press the key for unfolding/folding (B).

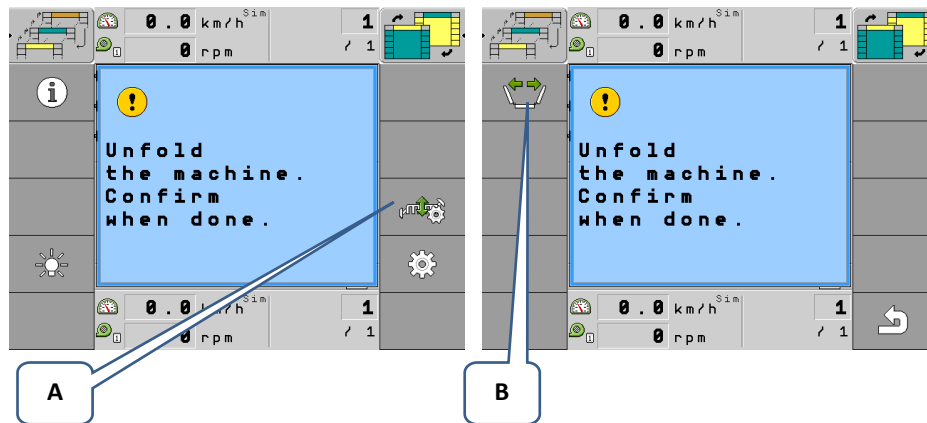

3. Release the pressure oil into the hydraulic circuit so that the machine unfolds. Firstly, the front preparatory section unfolds followed by the frames with the large wheels and the sowing bodies.

Picture 25 - Unfolding the machine

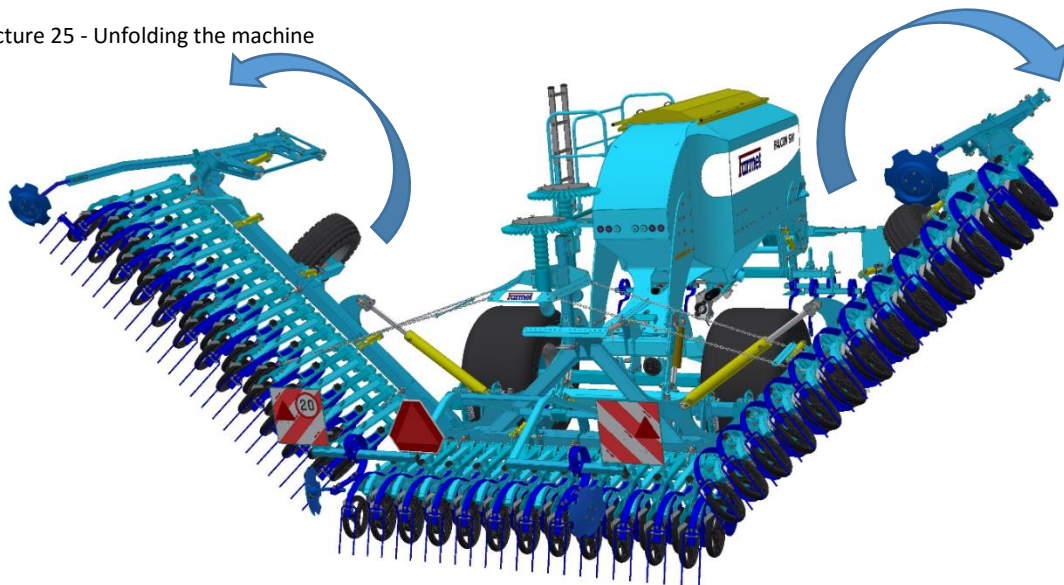

1. Pressurize the circuit when the machine has been completely unfolded. It is required for the correct function of the weight distribution.
2. When the machine is completely unfolded and the circuit has been pressurized, confirm the task of unfolding (C). The machine is now completely unfolded and the sowing application can be activated.

Picture 26 – Task confirmation

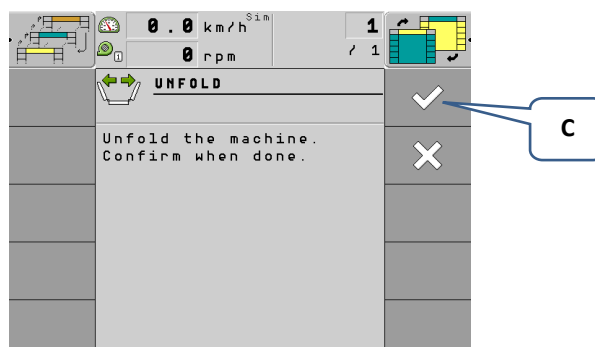

5.2. FOLDING THE MACHINE

When folding the machine, progress in a reversed way:

1. Lift the machine fully and close the valve of the front preparatory section (see Picture 30).
2. Turn on the folding/unfolding function on the display unit, see Picture 27.

Picture 27 - Unfolding/folding on

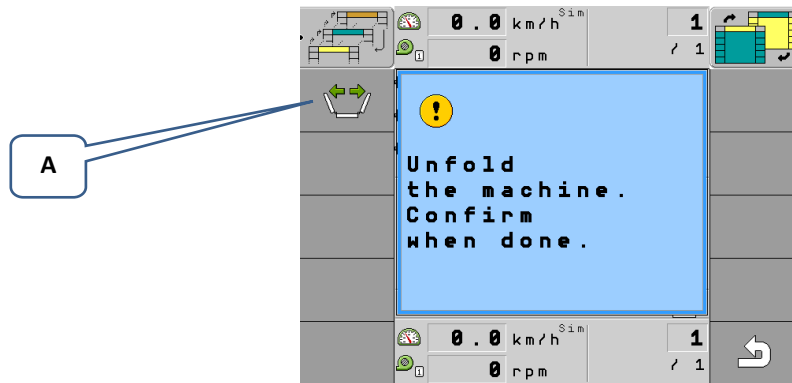

3. Release the pressure oil so that the machine folds into the transport position (B).

Picture 28 – Folding the machine

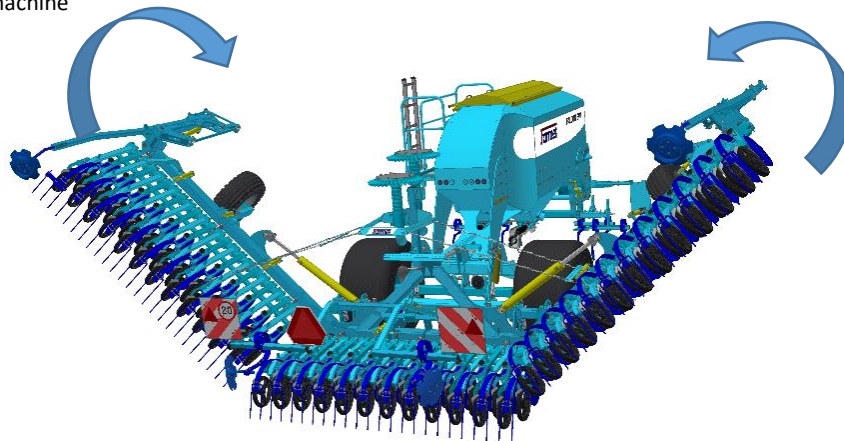

4. Then, the task of folding the machine must be confirmed. (C).

Picture 29 – Task confirmation

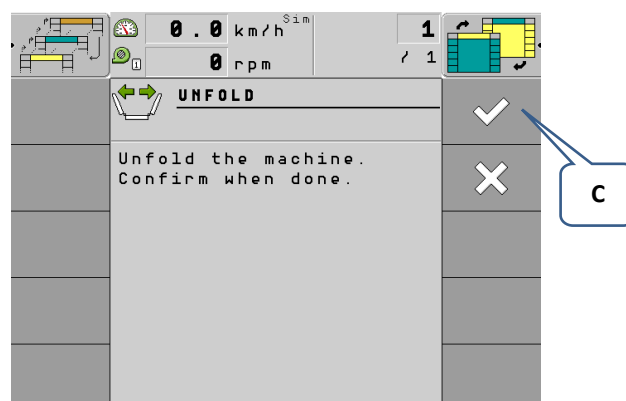

5. Secure the mechanical protection of the side frames of the front preparatory section.

Note – When the machine is folded, the rear sowing section is automatically lifted into the transport position. Lower the sowing section back into the working position after the machine has been unfolded by pressurizing the down pressure!!!

6. LOWERING AND LIFTING

6.1. LOWERING THE MACHINE

1. Open the tap of the ball valve of the piston-rods for lifting the front preparatory section.

Picture 30 - Ball valve, front section, position **OFF**



Picture 31- Ball valve, front section, position **ON**



7. FILLING UP THE SEED/FERTILIZER CONTAINER



- When filling up the container, always observe safety regulations and instructions.
- The machine must be fully unfolded and must be resting on the working bodies on the ground.
- Only fill up the container on a solid and flat surface and when the machine is standing still.
- Use the access ladder for access to the service platform.
- Remove and store the canvas.
- Remove the central brackets of the canvas.
- Fill up the hopper with the required type and volume of seeds/fertilizer.
- Return the central brace rods back and cover the hopper with the protecting canvas
- The platform is only intended for the operator for filling up the container.
- It is strictly forbidden to use the platform during driving and operation of the machine.
- The bearing capacity of the platform is limited to **3 persons or 280kg at the most!**
- Be extra careful when moving on the platform.
- **It is strictly forbidden to transport persons or cargo on the machine!**

Picture 32 – Filling up the container

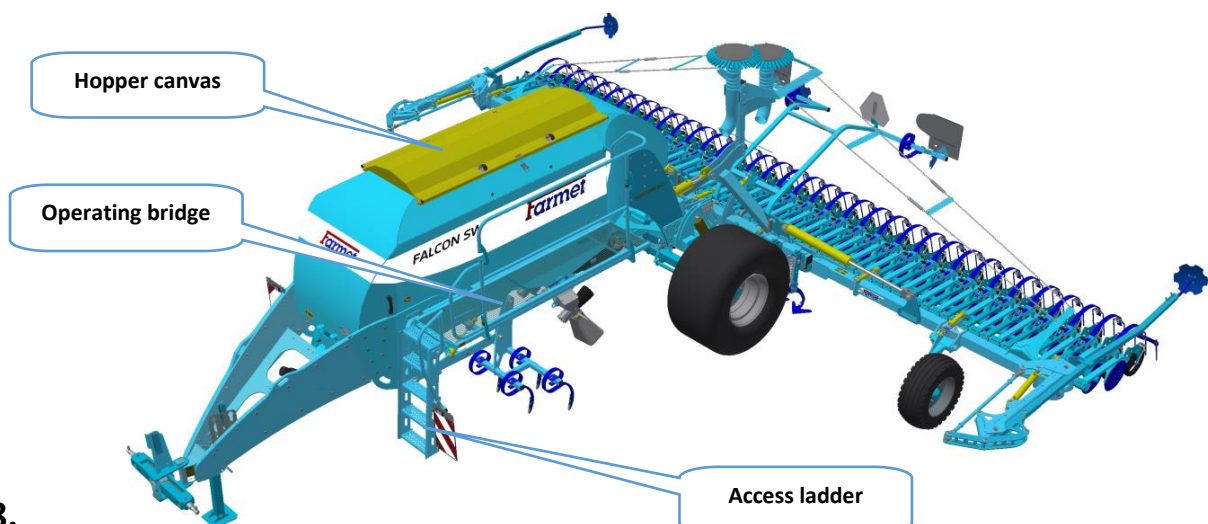

8.

8. SETTING OF THE SOWING BATCH

- The first step is to set the turnstile according to the calibration table.

SOWING TABLES AND TURNSTILE SETTING

Tab. 7 - Calibration table for fertilization

CALIBRATION TABLE FOR FERTILIZATION														
(APPROXIMATE VALUES) FOR THE <i>FALCON</i> SOWING MACHINES														
Fertilizer - kg/ha														
FEEDER SETTING														
mm	SCALE (mm)													
	20	25	30	35	40	45	50	55	60	65	70	75	80	85
kg	50	80	100	120	140	160	180	200	220	240	200	280	300	320

Tab. 7b - Calibration table for regular seeds and sowing with fertilisation

CALIBRATION TABLE FOR SOWING SEEDS								
(APPROXIMATE VALUES) FOR THE <i>FALCON</i> SOWING MACHINES								
SEEDS	WHEAT	RYE	BARLEY	OATS	PEAS	MAIZE	MUSTARD	
Vol. mass kg/dm ³	0,77	0,74	0,68	0,5	0,81	0,79	0,6	
SEEDS - kg/ha								
FEEDER SETTING								
SCALE (mm)	5	X	X	X	X	X	X	5 - 7
	7	X	X	X	X	X	X	8 - 10
	10	X	X	X	X	X	X	11 - 15
	12	X	X	X	X	X	X	16 - 20
	15	X	X	X	X	X	X	21 - 25
	20	50	45	40	30	50	50	30
	30	80	75	70	60	80	80	X
	40	100	95	90	80	100	100	X
	45	120	115	110	100	120	120	X
	50	140	135	130	120	140	140	X
	55	160	155	150	140	160	160	X
	60	180	175	170	160	180	180	X
	65	200	195	190	180	200	200	X
	70	220	215	210	200	220	220	X
	75	240	235	230	220	240	240	X
	80	260	255	250	240	260	260	X
	85	280	275	270	260	280	280	X
90	300	295	290	280	300	300	X	
95	320	315	310	300	320	320	X	
100	340	335	330	320	340	340	X	

Fine Seeds

Tab. 8 – Sowing table for fine seeds

CALIBRATION TABLE FOR FINE SEEDS kg/ha						
SEEDS	RAPE	ROTKLLE	GRASS	PHACELIA	POPPY	
Vol. mass [kg/dm ³]	0,65	0,8	0,36	0,22	0,4	
FEEDER SETTING						
SCALE [mm]	4				0,5 – 1,5	
	5	1,5 - 2	5	x	x	1,5 - 2
	6	2,5	6	x	x	2
	7	3	7	x	x	2,5 - 3
	8	3,5	9	x	x	x
	9	4	12	4	x	x
	10	4,5	15	6	x	x
	11	5	20	7	x	x
	12	5,5	22	10	x	x
	13	6	25	14	x	x
	15	x	x	x	5 - 10	x
	17	x	x	x	11 - 15	x
	20	x	x	x	16 - 20	x

Attention!!!

When sowing fine seeds, use the fine roller (micro sowing) and pull out the red wheel.



Picture 33 – Setting the feeder

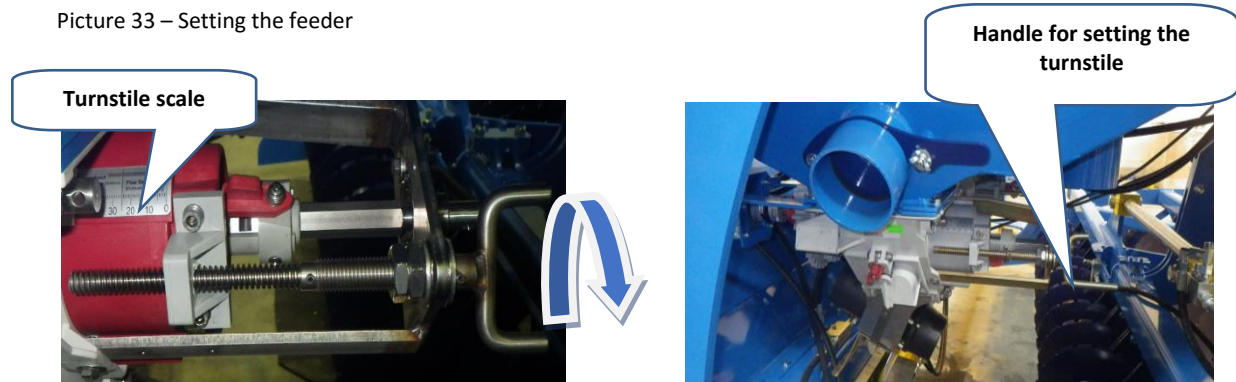

- The second step is to set the sowing dose in the electronic system:

In the case of two sowing devices, we must enter a full batch into the imaging unit on both sowing devices. Example: The required dose is 100 kg / ha - the required dose for the product and 100 kg / ha for dosers 1 and 2.

! All shown in blue is selected by the rotary cursor on the side of the terminal !

Picture 34 – Setting the sowing dose for two seed dispensers at the same dose (100 kg / ha both dispensers simultaneously)

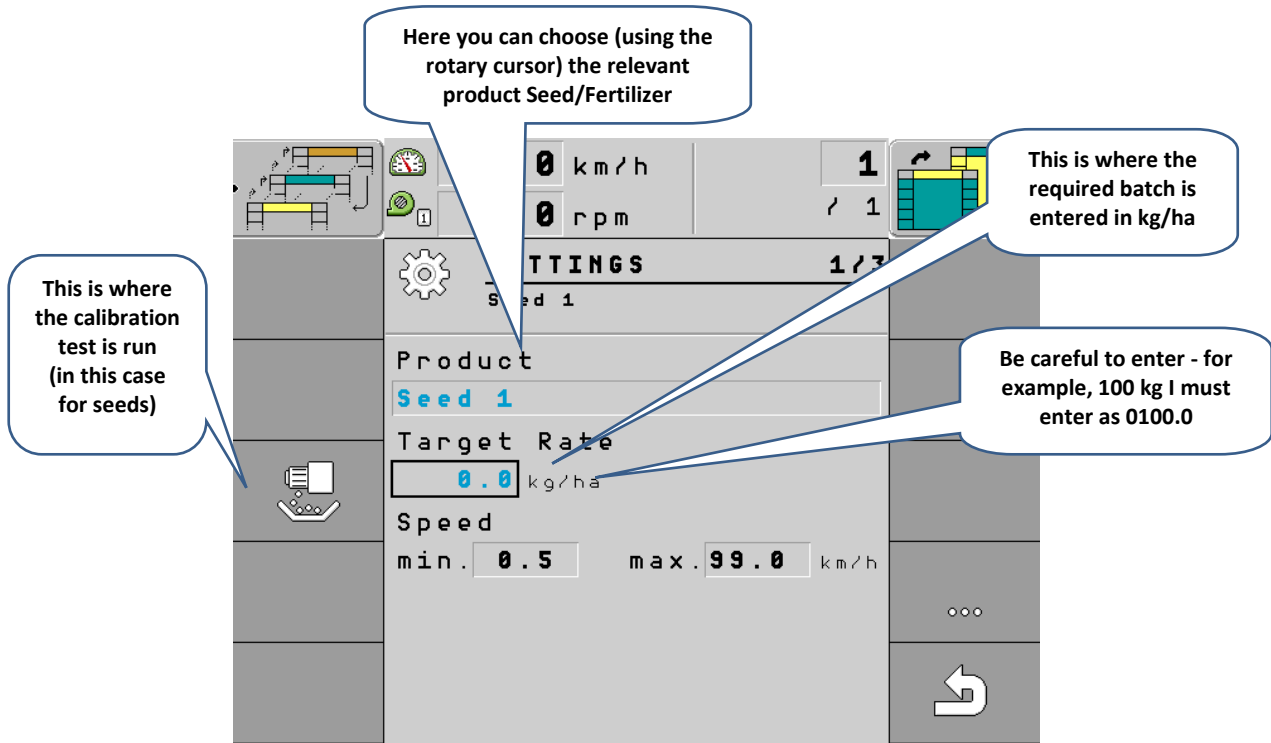

- The third step is the calibration test:

Picture 35 – Calibration test

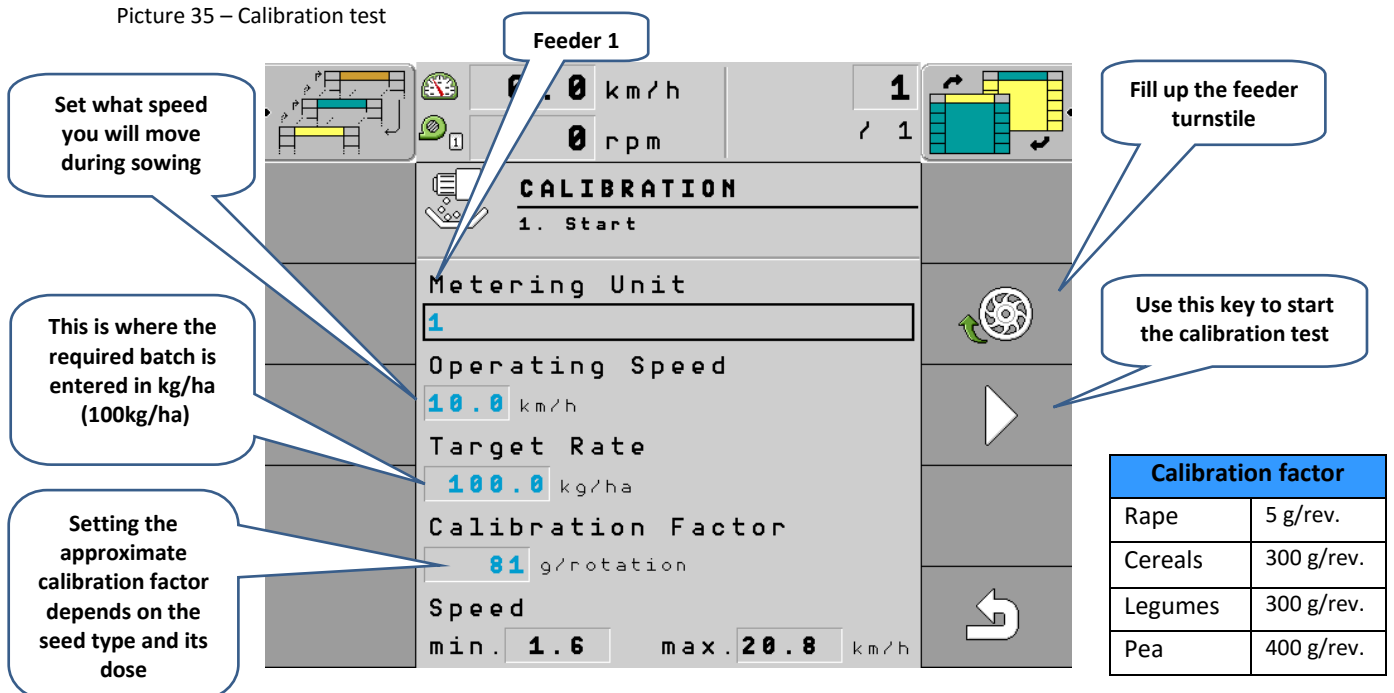

Procedure – place a bag that have been weighed below the sowing mechanism. Blind the opening which will prevent the seeds from falling into the pipeline. Then press the key to start filling the bag with seeds.

Picture 36 – Filling the bag



By pressing this key you start filling the bag with seeds (hold until there is a weighable amount in the bag)

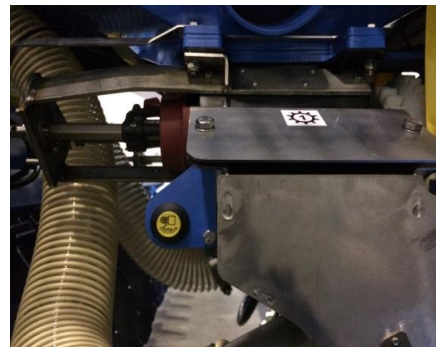

- The fourth step is to weigh the seed bag and enter the net seed weight into the imaging unit.

Picture 37 – Entering the weighed portion

The screenshot shows a calibration menu with the following fields and options:

- Speed:** 0.0 km/h, 0 rpm, 1 / 1
- CALIBRATION 3. Result**
- Weighed Value:** 0.605 kg
- Calculated Value:** 0.605 kg
- Deviation:** 0.0%
- Confirm:**
- Cancel:**
- Speed range:** min. 0.5 max. 15.9 km/h

Callouts provide the following information:

- "Enter the weighed portion here (using the turning knob)" points to the Weighed Value field.
- "Calculated deviation, first estimate of the system in relation to the actual weighing" points to the Deviation field.
- "If the range of speed is appropriate, confirm the calibration test" points to the Confirm checkbox.
- "This is where the range of speed available for sowing is displayed" points to the Speed range field.

! We will do the whole process for the second dispenser as well as the fertilizer!

- Correcting the sowing batch – the sowing batch can be changed during sowing as shown in Picture 38. The sowing batch is adjusted by 10 %.

Picture 38 – Correcting the sowing batch

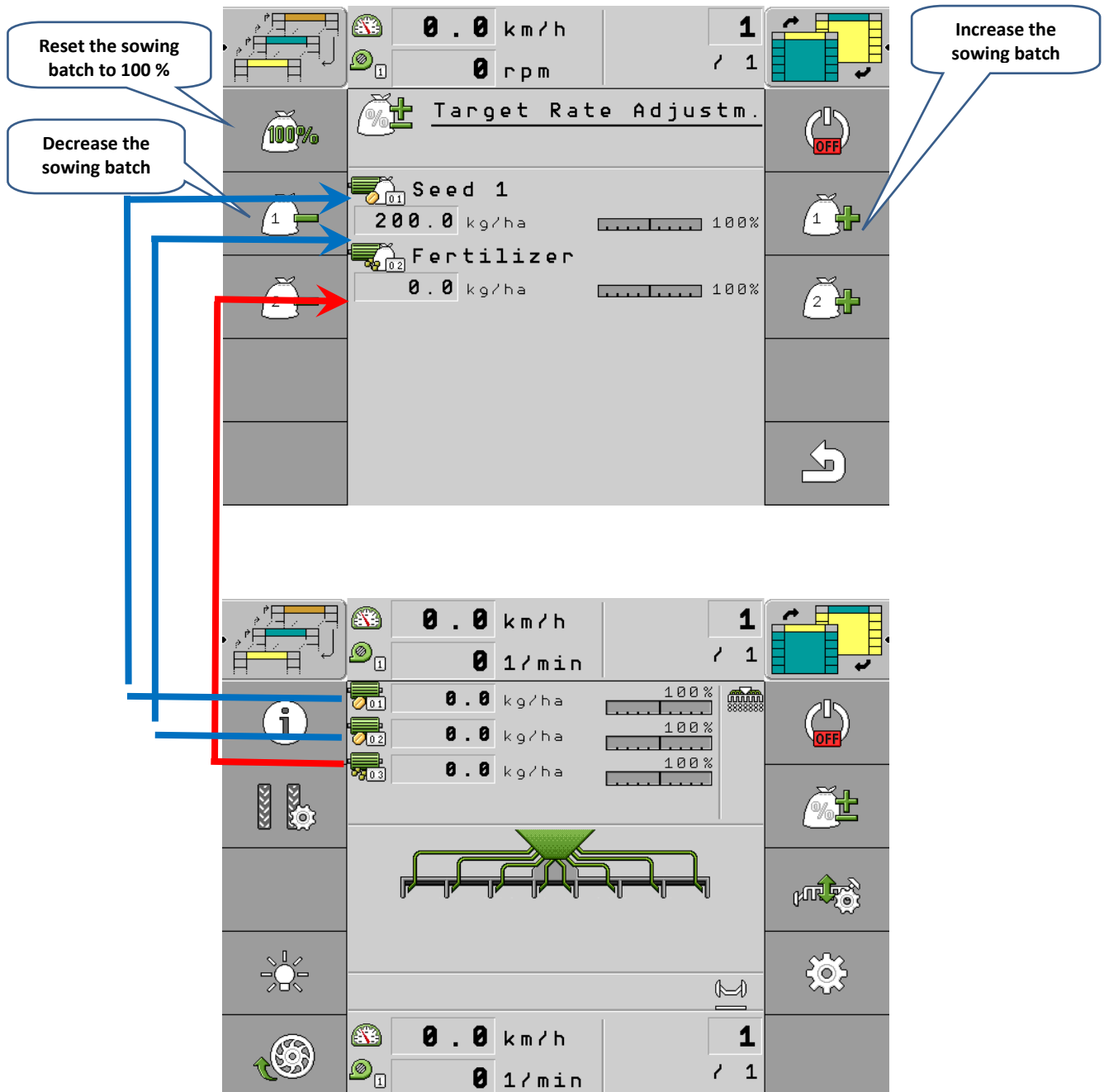

- The display unit then adjusts the feeding according to the newly set sowing batch

8.1. SCREW DISPESER FOR SIDE-DRESSING

- 1) Black hydraulic circuit.
- 2) The hose marked with **two** strips is always a pressure hose.
- 3) The screw dispenser does not have an adjustable turnstile - doses are regulated by the screw rotation.
- 4) Ideal hydraulic oil flow rate: 10-15 l/min.

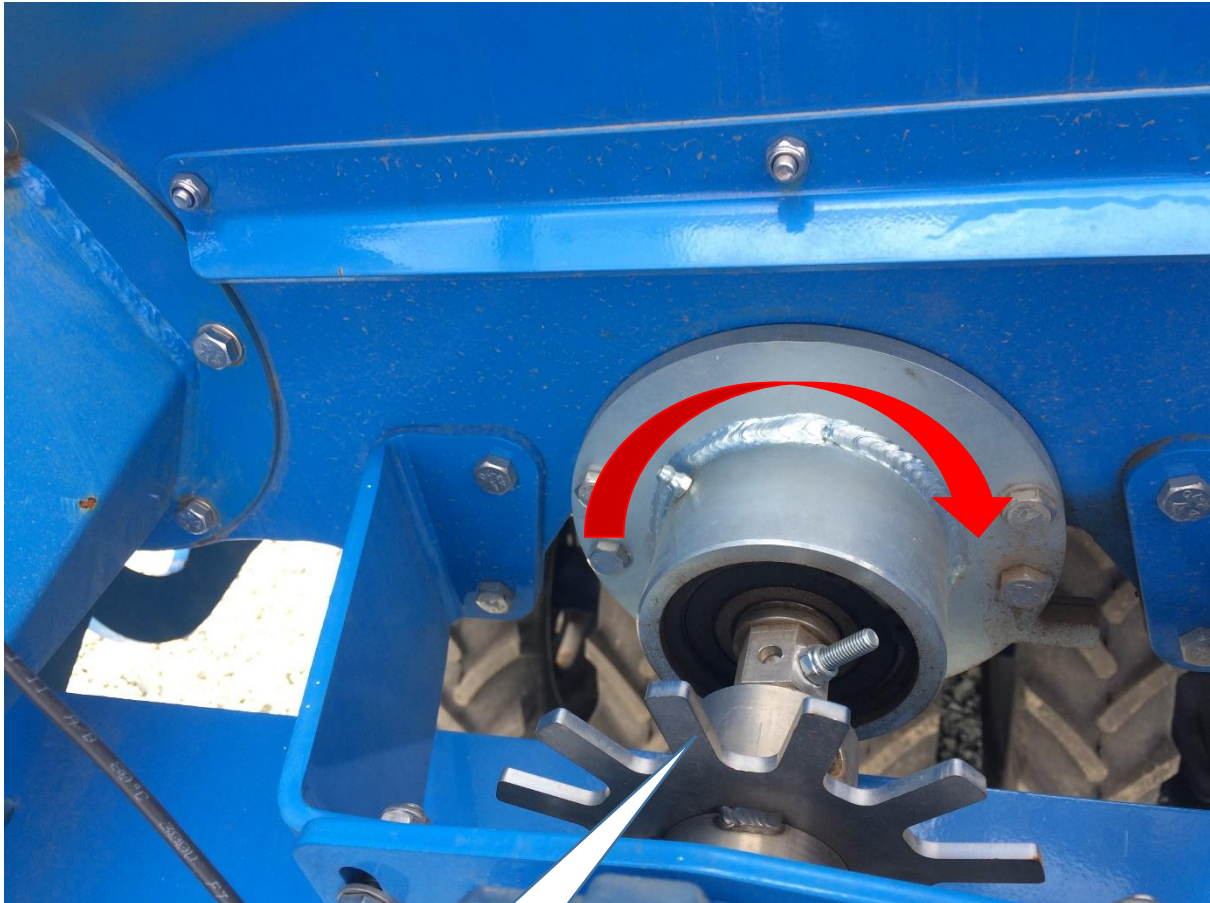

The screw dispenser must always turn to the right when looking at it from the front.

8.2. SETTING THE FINE SEEDS SOWING

The minimum setting of the turnstile for fine seeds is 5 mm. Lower setting may cause inaccuracies in seed feeding. Poppy seeds are an exception as due to the very small size of the seeds and the seed rate the turnstile can be opened to 4 mm.

Before filling the seed into the hopper, it is very important to check the purity of the turnstile and the dosing planer on the dosing roller.

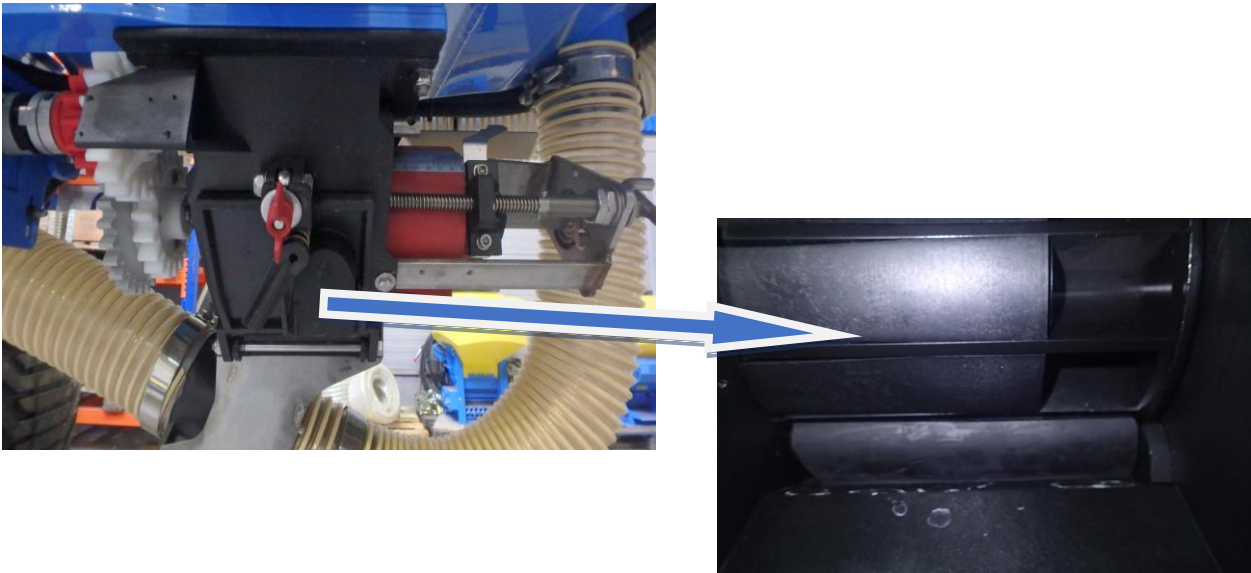

For fine seeds, set the setting roller to position **0** – the container must be cleaned and closed beforehand and the seeding mechanism must be empty. Place the closing valve on the body of the feeder into the cut on the hexagon shaft. This way the roller of the feeder can move only within the range from 0 to 25 mm.

Picture 39 – Setting of the micro-sowing

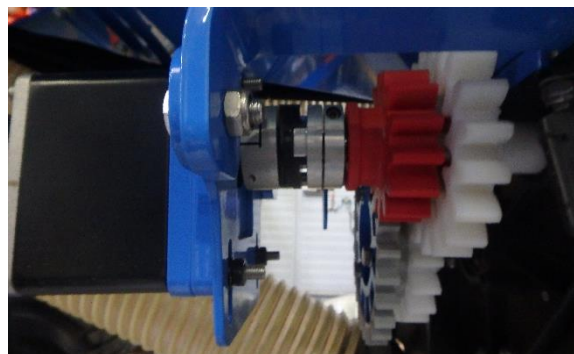

9. SETTING VENTILATOR SPEED ACCORDING TO SEEDS

For machines without fertilization

Crop	Revolution of fan (rev/min)
Cereals	4000 - 5500
Legumes	4000 - 5500
Corn	4000 - 5500
Rapeded	3000 - 3500
Clover	3000 - 3500
Grass	3000 - 3500

For fertilizing machines

Crop	Revolution of fan (rev/min)
Cereals	5000 - 5700
Legumes	5000 - 5700
Corn	5000 - 5700
Rapeded	5000 - 5700
Clover	5000 - 5700
Grass	5000 - 5700

The values stated above are for information only.

!!! When the ventilator speed is insufficient, the seeding amount decreases, the air system gets clogged or seeds start falling out from the mixing ejector of the seeding mechanism!!!

10. ADJUSTMENT OF THE WORKING PARTS OF THE MACHINE

Picture 40 - Diagram of the working parts

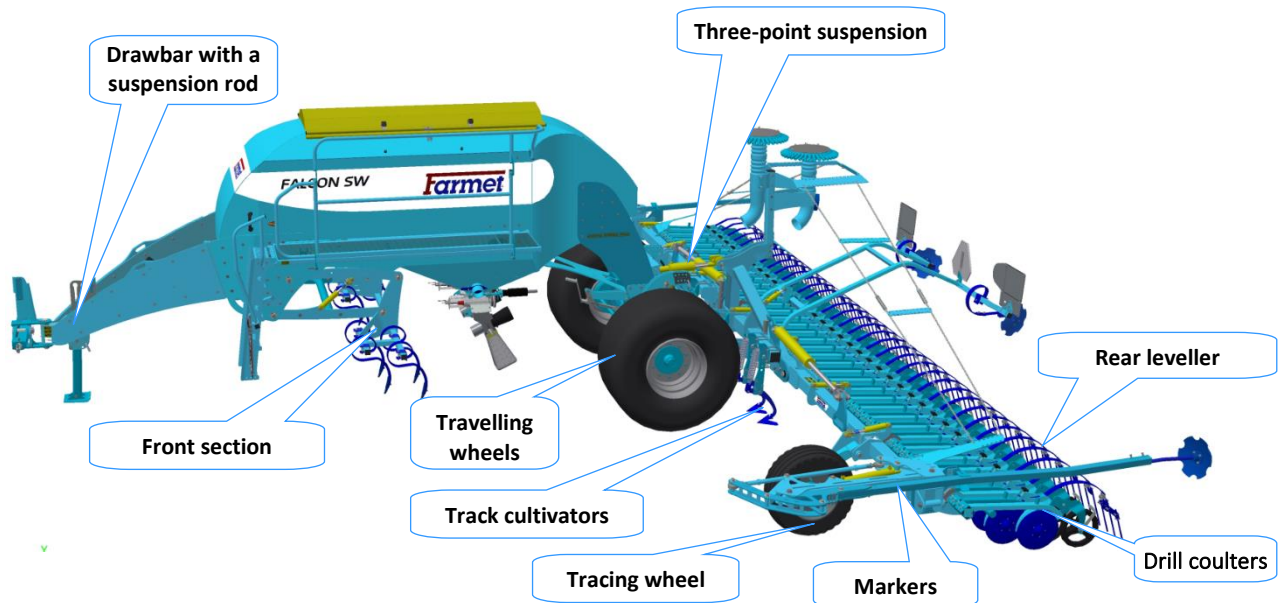

10.1. ADJUSTING THE MACHINE WORK DEPTH

- 10.1.1 By TPS arms of the tractor
- 10.1.2 Setting the depth of sowing
- 10.1.3 Setting the down-pressure on sowing bodies
- 10.1.4 Adjusting the levelling after the sowing bodies
- 10.1.5 Adjusting the working depth of the front preparatory section
- 10.1.6 Adjusting the levelling
- 10.1.7 Setting the markers

Tab. 9 - Sowing depths

Table of approximate sowing depths of FALCON SW *	
Setting the depth	Approximate depth (mm) *
1	10
2	20
3	30
4	40
5	50
6	60
7	70
8	80
9	90

Table of recommended sowing depths of selected farming products	
Farming product	Recommended sowing depth (mm)
WHEAT	30 - 50
RYE	30 - 50
BARLEY	30 - 50
OATS	30 - 50
BEANS	30 - 60
PEAS	30 - 60
LUPINE	30 - 60
VETCH	30 - 60
MAIZE	30 - 60
SWEDE	20 - 30
LUCERNE	10 - 20
GRAMINOIDS	10 - 20

* The number of the set working depth is for information only and it may be influenced by the soil structure and properties. The depth should always be tested on the actual field before sowing and the actual depth of depositing seeds in the soil has to be checked!!!

There is a threat of imbalance and irregularities of growth when the sowing depth is not sufficient and there is subsequent drought!!!

The use of trail cultivators is recommended to eliminate compaction in the place of the tractor wheel tracks.

10.2. ADJUSTING THE MACHINE BY TPS ARMS OF THE TRACTOR

Set the machine so that it is on the same level as the ground with the use of TPS arms of the tractor. This will ensure the same depth of soil processing in the front and rear of the machine.

Picture 41 - TPS adjustment

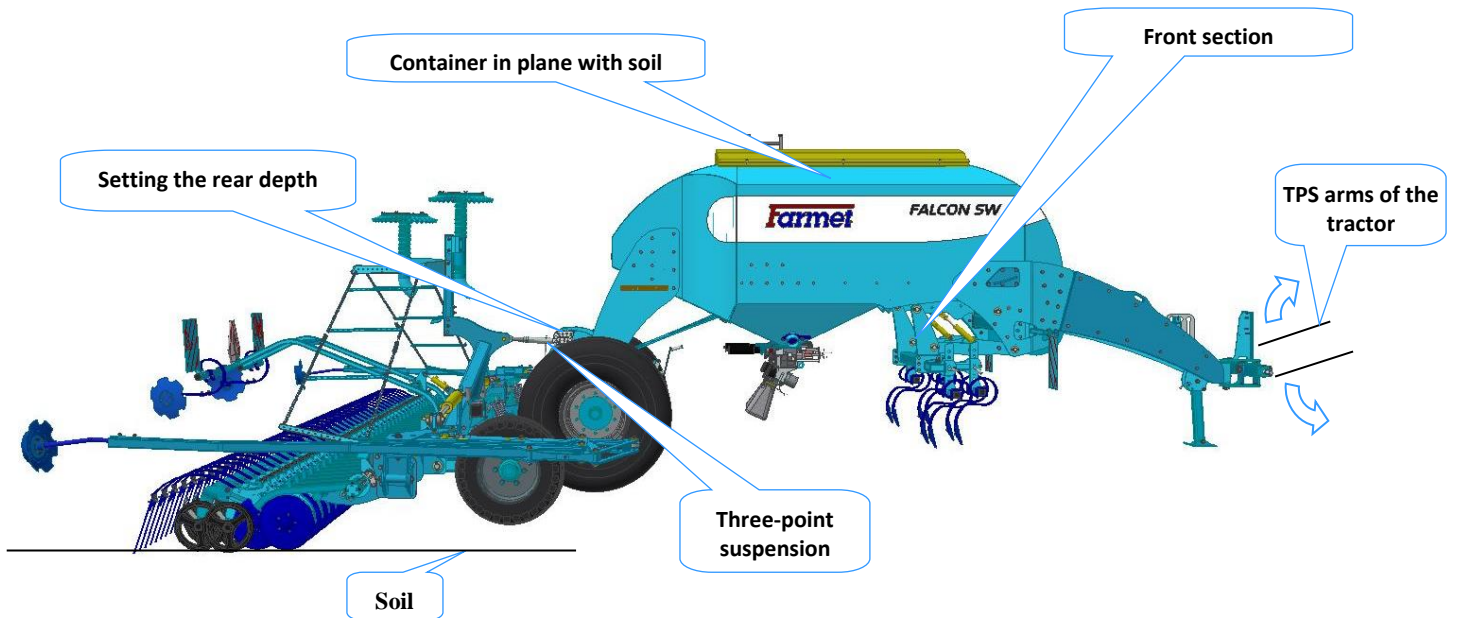

10.3. SETTING THE THIRD POINT PISTON ROD

To properly adjust the machine for sowing at the right depth, it is necessary that the third-point piston rod is fully drawn out.

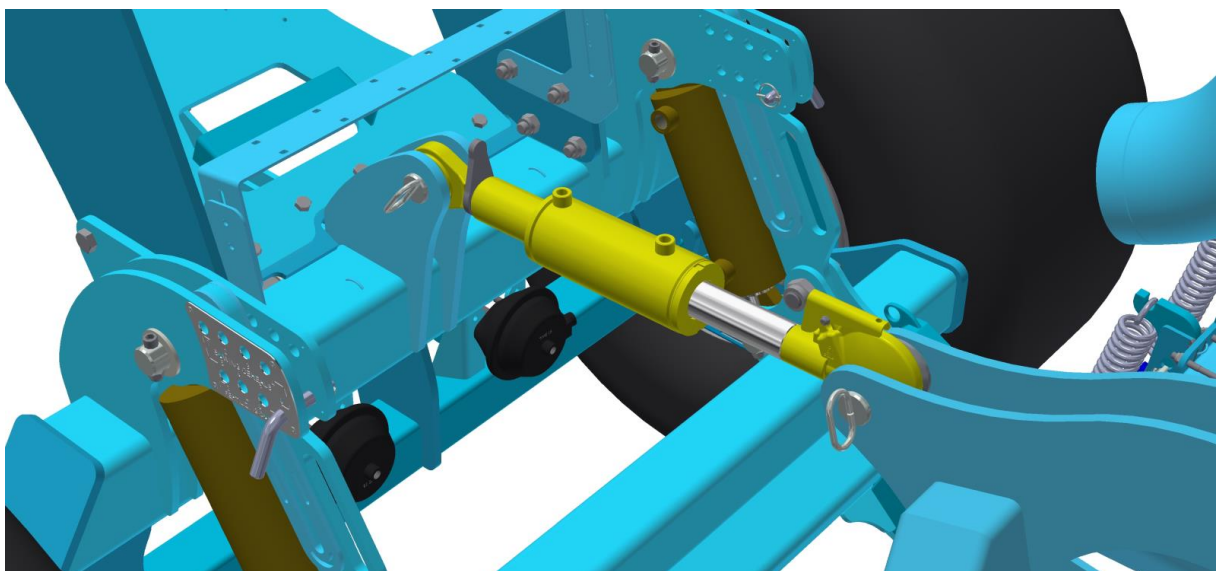

10.4. SETTING THE SOWING DEPTH

The sowing depth is set using a pin adjusted in the holes of the adjusting slotted piece. Each opening corresponds with a particular sowing depth. This only applies when the machine is on flat ground

Picture 42 – Slotted piece of the setting depth

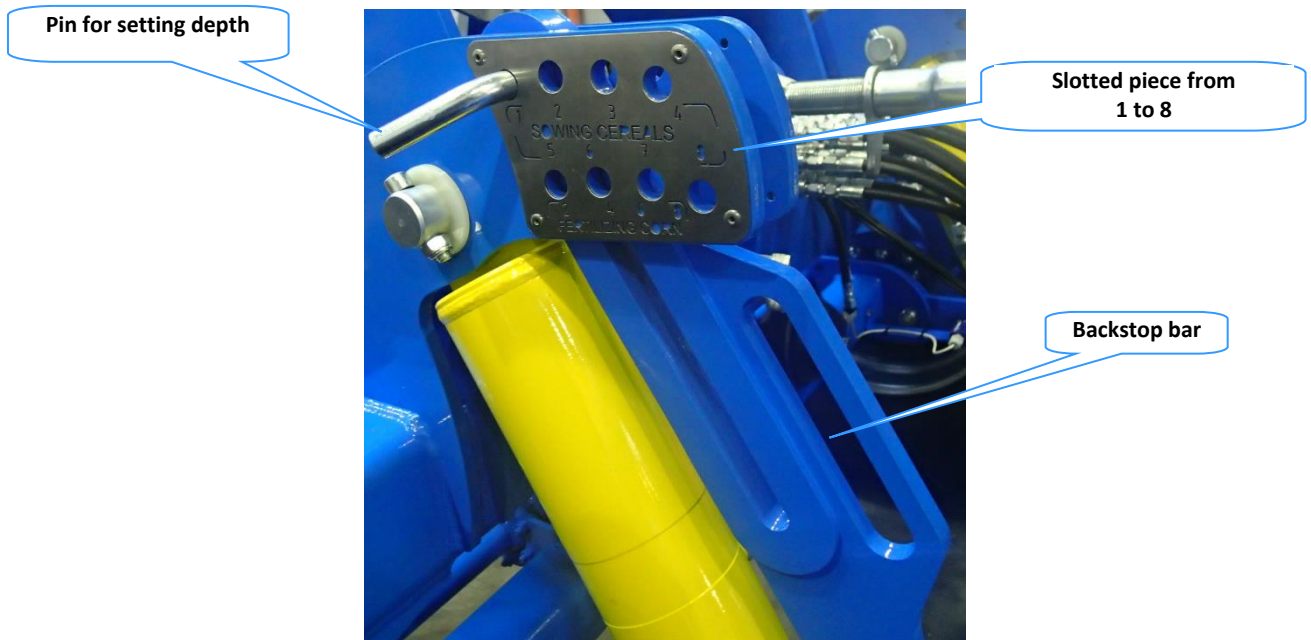

Setting the openings in the stop panels for sowing cereals

Picture 43 – Openings in sowing stop panels

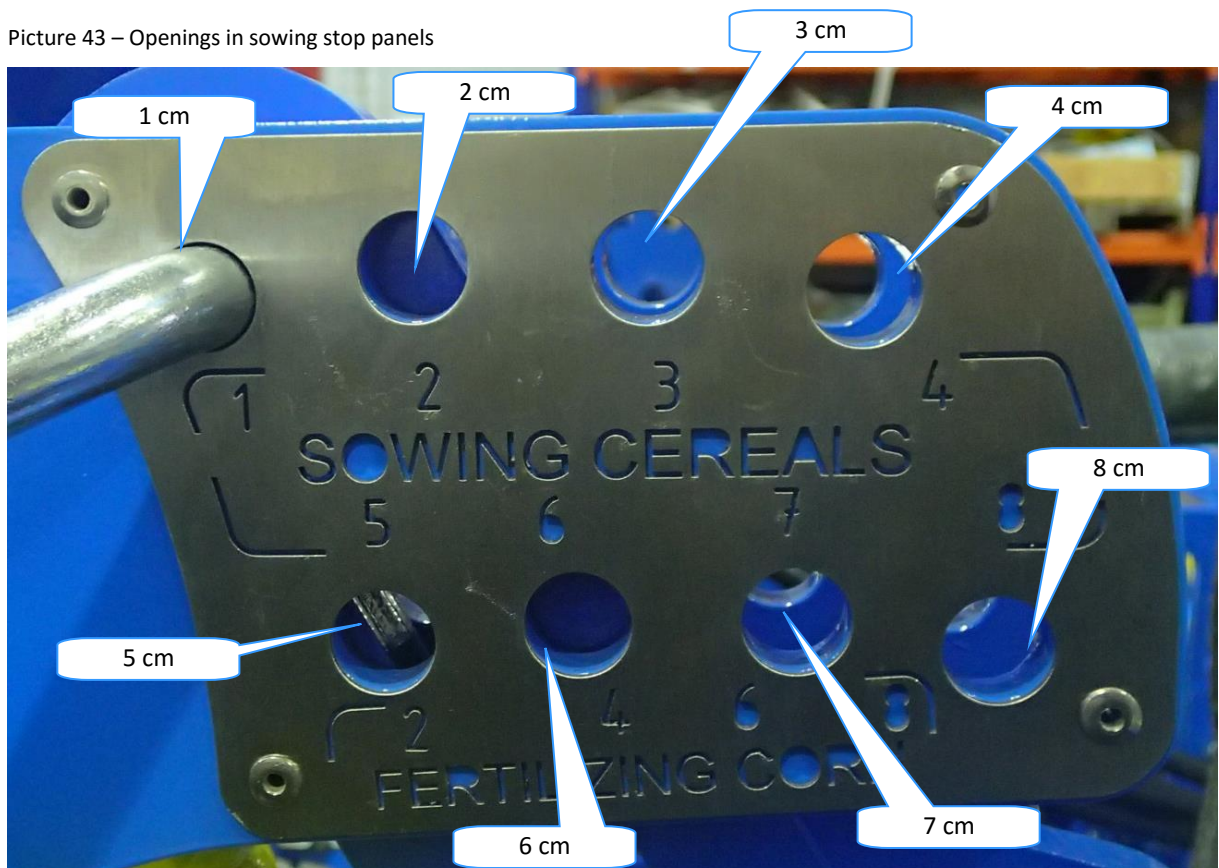

When the depth of the machine is set, we have to set the clips on the tracing wheels. For example, when you want a depth of 1cm, set all the clips on the tracing wheel, when you want a depth of 8cm, only one clip (silver) is included on the tracing wheel. The numbers and the clips correspond with centimetres.

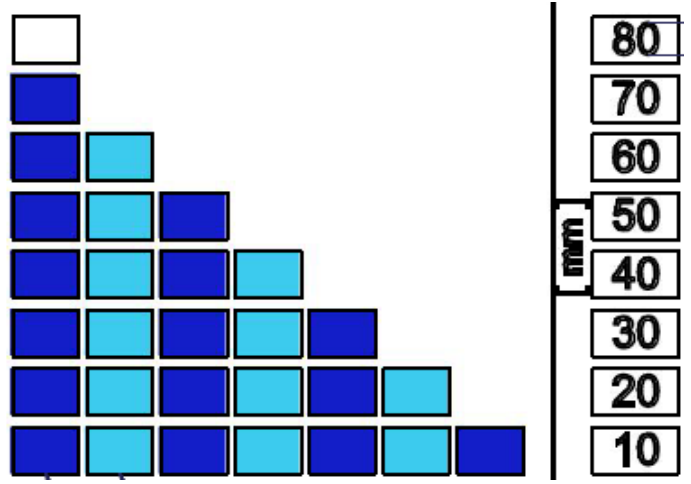
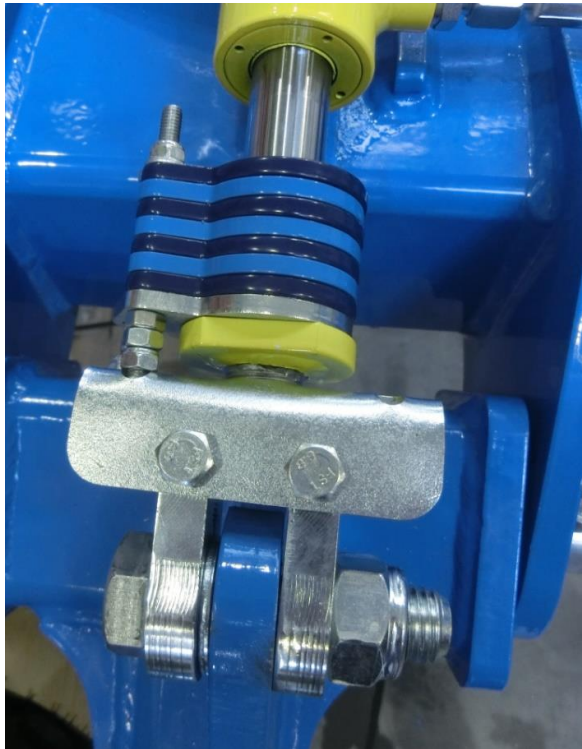

Setting the openings in the stop panels for additional fertilisation when sowing maize

Picture 44- Openings in the stop panels for additional fertilisation

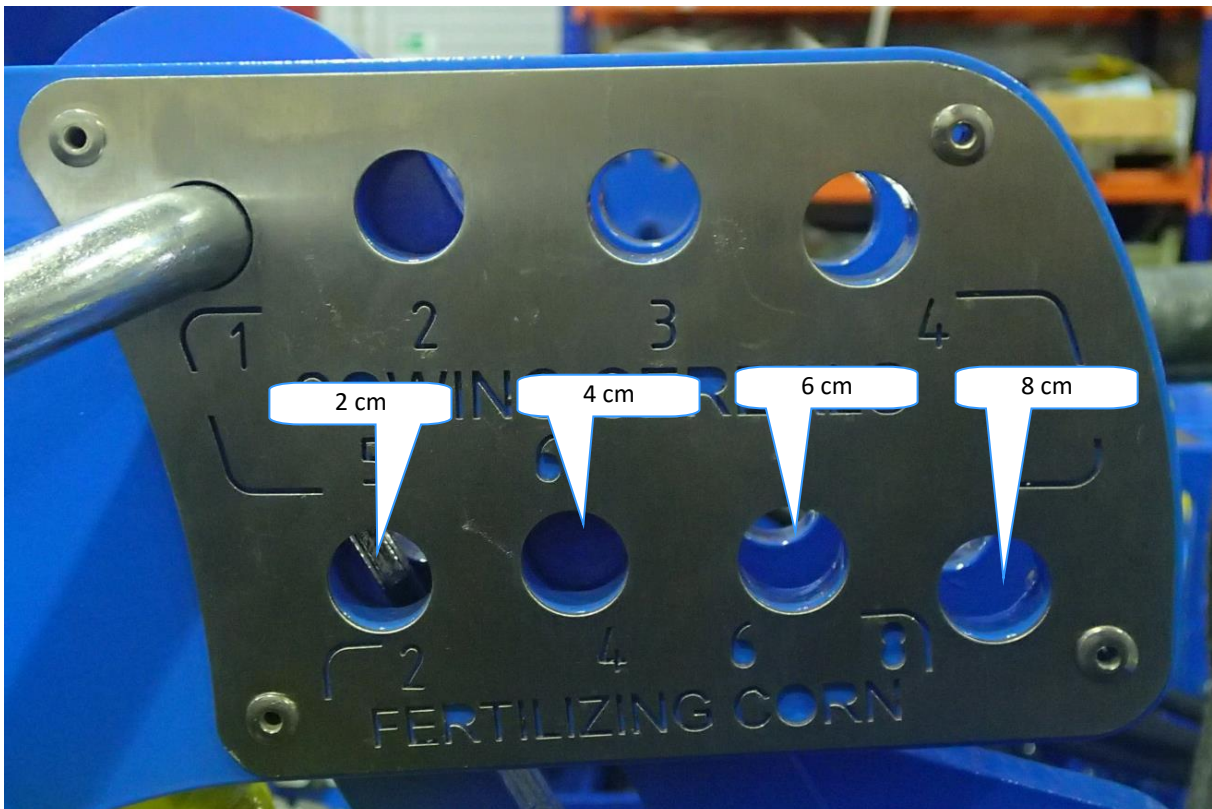

10.5. SETTING THE DOWN-PRESSURE OF THE SOWING BODIES

The required down-pressure of the sowing bodies is set using the hydraulic pressure in the tractor. The circuit is equipped with a ball valve (marked green) in case of a loss of pressure due to the leakage of the hydraulics in the tractor. When you set the required pressure, the pressure will not decrease once the valve is closed.

The following parameters must be adjusted for correct setting:

1. Required sowing depth
2. Soil conditions
3. Pressure extent

The parameters above may only be set correctly in the field and tested directly under the given soil conditions. The operating staff **must** always consider the soil conditions! It is not possible to set maximum pressure in loose and soft soil conditions. On the other hand, it is not appropriate to set minimum pressure in hard and heavy soil conditions as the coulters would not cut into the soil.

When the drill coulter pressure is too high and the soil conditions have not been estimated properly, the following may occur:

The compacting wheel of the drill coulter is forced too deep into the ground, lifting the compacting pneumatic roller, resulting in drill coulters not inserted in the ground. This leads to failure in reaching the required depth of sowing, wrong turning of the drill coulters and incorrect compaction of the soil before the drill coulters, or to their complete stopping in the worst case. This may lead to errors in placing seed clusters in the soil.

Picture 45 – Location of the sowing body pressure gauge

Approximate down-pressure of the sowing bodies of FALCON SW *	
Pressure gauge	Approximate force (kg) *
20	20
50	50
100	70
150	115



Correct procedure for setting pressure and sowing depth:

1. Set the required sowing depth.
2. Decrease the pressure of drill coulters to minimum.
3. Unfold the machine into the working position and travel a few meters.
4. Check the required sowing depth.
5. If required, increase the drill coulter pressure.
6. Travel a few meters again and check the change.
7. Proceed as described above until you achieve the required depth of sowing.

If you cannot reach the required values, repeat the procedure with the following higher depth of sowing.

The optimal pressure setting is between **20 to 60 bar** with regard to the current soil conditions.

10.6. SETTING THE LEVELLER BEHIND THE SEED BOOTS

The depth and angle are both set in one step. By changing the angle you will achieve lower catchment of plant residues. At the same time, the depth of processing and the down-pressure will decrease.

Picture 46 – Setting of the leveller

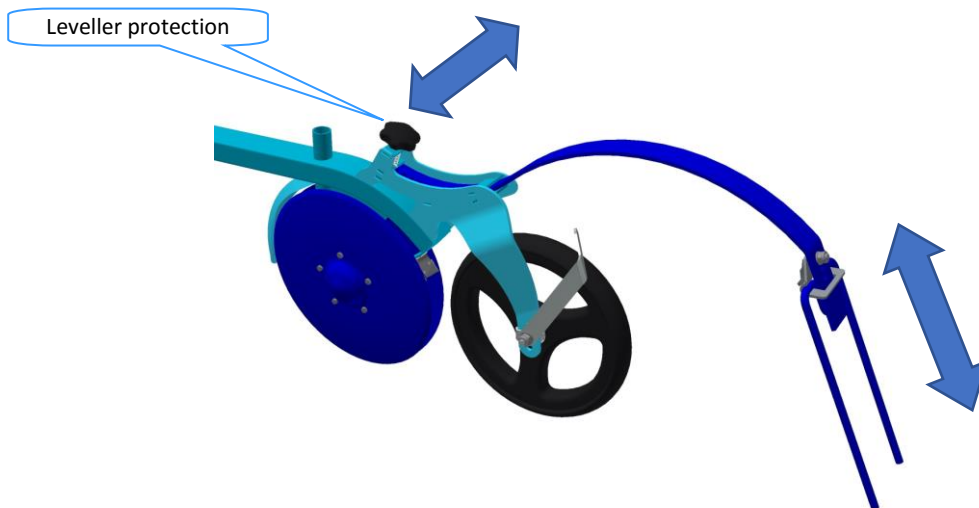

10.7. ADJUSTING THE WORKING DEPTH OF THE FRONT SECTION

The working depth of the front section is set using spacers on the piston-rod for lifting that are placed on the piston rod. The depth always corresponds to the combination of the individual spacers, see Table and the sticker on the machine.

It is important that the working depth of the front section never exceeds the required sowing depth for ideal operation of the machine.

Picture 47 – Setting the depth of the front section

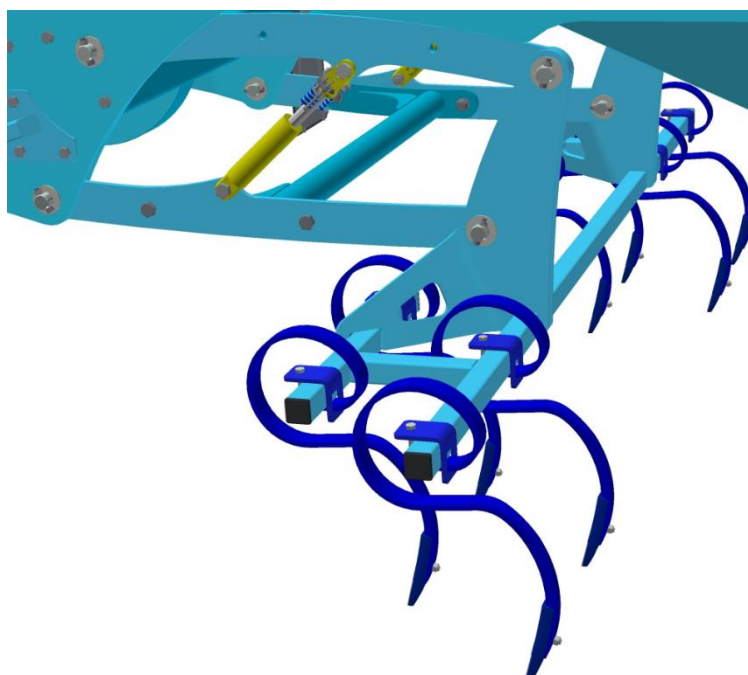

1		80
2	■	70
3	■	60
4	■ ■	50
5	■ ■	40
6	■ ■	30
7	■ ■	20
8	■ ■ ■	10

mm

10.8. SETTING THE MACHINE TRACK CULTIVATORS

The machine track cultivators are set individually according to the soil conditions in which the machine is currently working.

Picture 48 – Setting the machine track cultivators

10.9.

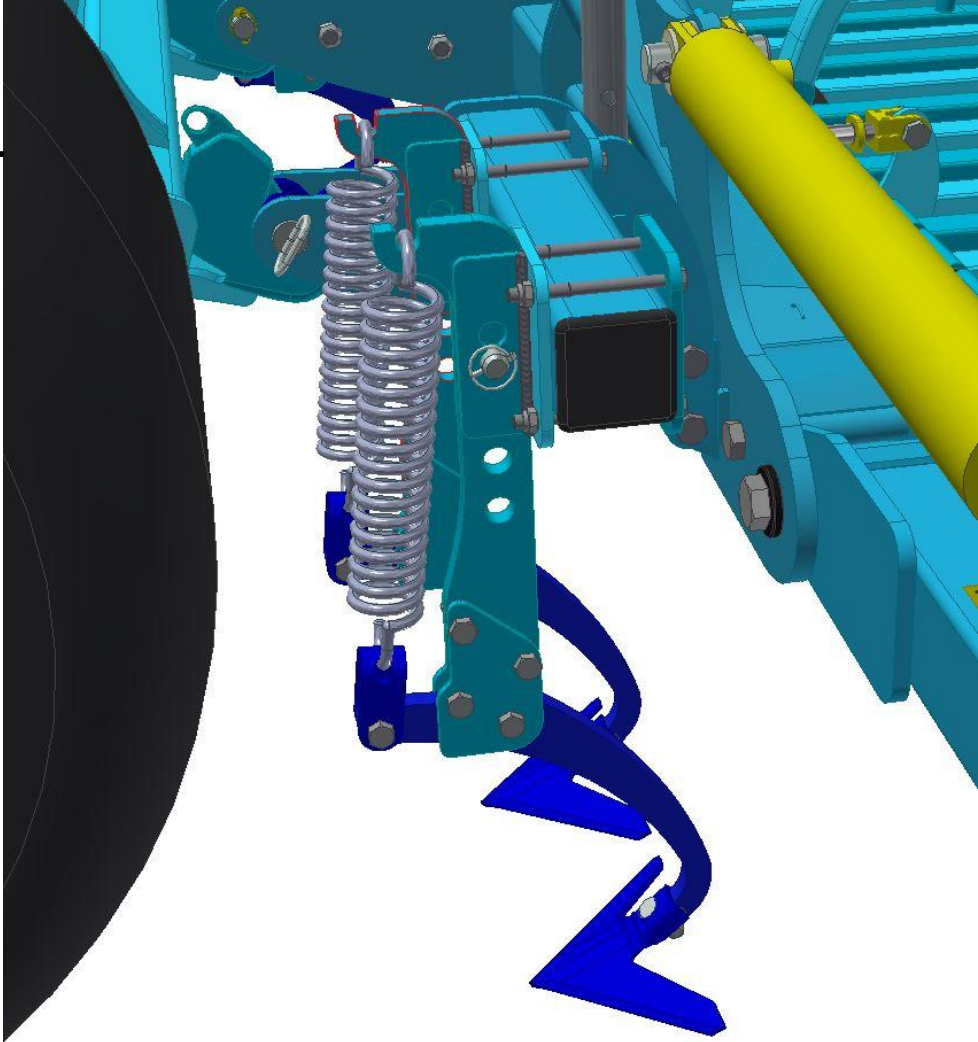

10.9. SETTING OF THE MARKERS

The markers can only be adjusted to the centre of the tractor; they trace the terrain and each marker can be controlled separately and they are hydraulically collapsible. The speed of opening a marker is regulated by choke valves. One rule applies that you should always choke the flow of oil returning from the piston-rods of the markers. That means that the valve on the oil tube returning from the marker piston-rod is throttled (regulated). Set the choke valves as needed and observe all instructions of safety at work.

The guarantee will not be accepted if there has been an unauthorized intervention in the system. In case of any defects in the system, contact the Service Department of the production plant.

The distance of the marker disk coverage is always from the centre of the outermost disc body. Always test in practice on the field.

Picture 49 - Setting of the markers

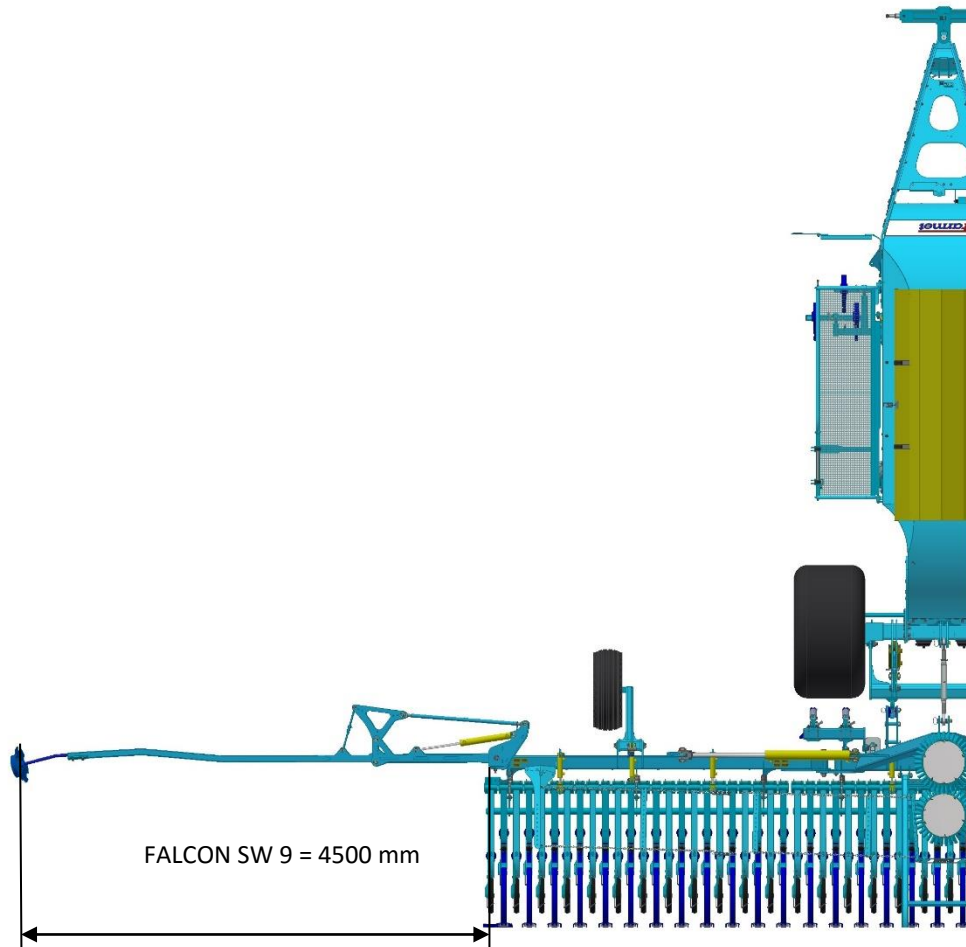

11. SUMMARY OF TASKS BEFORE THE COMMENCEMENT OF WORK

1	Pull the Falcon with the pulling device	
2	Connect the return hydraulic hose	
3	Connect the other hydraulic hoses	
4	Connect the lights	
5	Connect the machine electronics.	
6	Lift the machine's leg	
7	Unscrew the front section pins	
8	Open the axle pressure valve	
9	Open the front section valve	
10	Turn on the sowing machine terminal	
11	Pressure down due to machine splash	
12	Spread the machine	
13	Check the seed cleanliness	
14	Check for leakage of the planer in the seedbed	
15	Check the flow of the fertilizer hoses	
16	Check the seed hose for continuity	
17	Pour the seed	
18	Pour the fertilizer	
19	Check and adjust the seeder plane	
20	Set the lower end of the tractor's TPS	
21	Set the sowing depth	
22	Adjust the depth of the front section	
23	Set the dose in the electronics	
24	Set the value on the doser	
25	Perform a test shot	
26	Enter the value of the weighed sample into the terminal	
27	Ensure that the seed speed range is optimal - 1,5-20 km/h	
28	Set sensor sensitivity according to the table in the manual	
29	Set the priority on the fan's hydraulic circuit	
30	Adjust the oil flow for the fertilizer hydromotor	
31	Set the fan speed, by seed and batch	
32	Set the required hydraulic functions - indicators, track markers, etc.	
33	Set the required pressure on the seedbed, depending on the soil conditions (20-60bar).	

12. ERRORS



Fan is
rotating too
slowly.

The fan speed is too low

Cause:

Poorly aligned number, low flow hydraulic motor oils



Metering drive
is stationary.

Metering drive is stationary

Cause:

Poorly adjust number, jammed dispenser



Metering drive
regulation
range exceeded.

Metering drive regulation range exceeded

Cause:

Excessive speed kit / too slowly

ional Actuator 1



Metering drive
cannot maintain
target rate.

Can not reach the desired values

Cause:

Insufficiently adjusted sensor, clutch slip, engine cable break .

ional Actuator 1

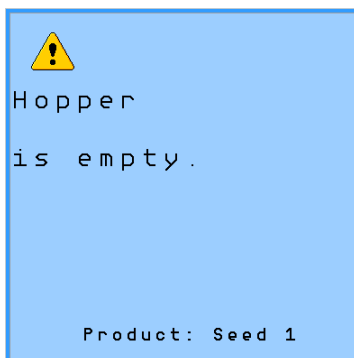

Hopper is empty

Cause:

It is necessary to replenish the seed/fertilizer

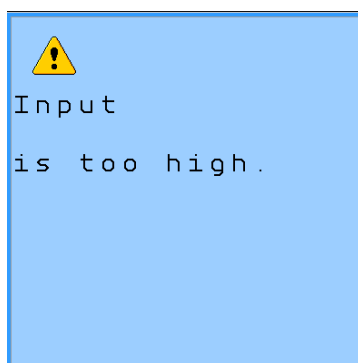

Input is too high

Cause:

Entered value is too high

SEED SENSORS

00 00 = no error (sensor number)

00 01 = Disconnected cable (number sensor is the last known good sensor)

00 09 = Sensor reset (sensor n / a)

n.	Fault	Cause	Type of cause	Removal
1	The fan speed fluctuates	Incorrectly adjusted fan sensor	Electronic	Sensor settings according to the instructions
		Faulty fan sensor	Electronic	Check sensor function, replace
		Incorrect or insufficient oil flow	Hydraulic	Checking the flow rate of the tractor control, correct adjustment according to tractor type
		Small size of free return quick coupling	Hydraulic	The size of the free return quick coupler must be min. ISO20
2	The beams are in the upper position at different heights	Badly welded beams, crooked frames	Mechanical	Inspection of beams and frames, or replacement
		Unscrew one of the lifting pistons to the end position	Hydraulic	Check the piston rods, check the nozzles to prevent any of them from clogging
3	Beam of sowing coulters are receding at different heights	Unscrew one of the lifting pistons to the end position	Hydraulic	Check the piston rods, check the nozzles to prevent any of them from clogging
		Set different depths of stitches on individual frames	Mechanical	Check the setting of the end depth stops, correct setting on all the same
		Set too much pressure on seed drills	Hydraulic	If the soil is very hard and too much pressure is applied to the seed drill, you can not cut any more
		When standing on the ground and recessing the bots.	Mechanical	Due to soil resistance, individual beams at different heights can only be lifted so that all the boots are evenly cut into the ground and the beams align themselves
		Collisions of individual beams between themselves.	Mechanical	The beams are locked in place after the recess. Sometimes you only need to climb and the beams align.

4	From the dispenser or mixer, the seed flies out	Clogged air system	Mechanical	If the main air line is clogged from the dispenser to the distributor, the seed can not pass and flies out of the dispenser.
		Too high airflow	Mechanical	When the airflow is set too high, the mixer nozzle can generate resistance and instead of leaving the seed further into the distributor, it flows into the mixer to swirl and flutter out.
		Too much seed or fertilizer	Electronic	The mixer is beyond the limit of functionality, it does not take more seed and clogs. Reduce the sowing rate or add more air if possible.
5	The dispenser motors do not spin after the recess	Badly adjusted antenna sensor	Mechanical	Set the sensor so that the sensor turn on
		Incorrectly adjusted pressure sensor	Hydraulic	If the sensor is set to low pressure, then at any pressure tip the engine stops. The sensor needs to be tightened.
6	Sowing sensors often report a flow error	Incorrectly set sensitivity to the seed	Electronic	Check the sensitivity settings and change the setting according to the instructions for the type of seed

7	The machine does not unfolding as it is, the footpath goes into a collision with the front section	Disconnected or faulty quick couplings at the front section	Hydraulic	Check the correct connection of the hydraulic hose couplings to the front section connection.
		Faulty end valve for unfolding the front section	Hydraulic	Check that the end valve is not stuck or the stop is in the correct position.
8	The wheels are above the surface, they do not rotate and do not work	Poor pressure set	Hydraulic	Set either very low pressure or very large against a very hard surface. Check and optimize.
9	The main wheels of the main cylinder are in the air	the machine is not unfolded	Hydraulic	The machine is not fully tilted, not tilted by the appropriate hydraulic function.
10	Error: The dispenser does not rotate	Allowed mechanical coupling of doser and engine	Mechanical	Check the clutch to see if it is allowed, so the motor rotates and the dispenser is standing. Tighten the clamp on the coupling.
		Incorrectly adjusted dispenser sensor	Electronic	The engine rotates, but the sensor does not respond and does not count the speed, the system behaves as though the engine was standing. Check whether the diode is illuminated on the sensor or adjust the sensor distance from the star according to the instructions.

11	Disagree about 50%	Bad dosages required	Electronic	Check the sowing batch and set the sowing method, or set it all again according to the instructions.
		Incorporated half gears on the dispenser	Mechanical	Check the sowing gears and the correct setting of the dispenser.
		Poorly performed and entered the seed test	Electronic	Check the seed drill procedure. For example, you can also exclude the bag weight option. Perform the sowing test again.
12	Does not approve sowing up to 20%	Badly done seed drill	Electronic	Check the seed drill procedure. For example, you can also exclude the bag weight option. Perform the sowing test again.
13	do not correspond to the hectares worked per computer	It disagrees with the speed of the radar and reality	Electronic	
		Wrong insertion of the machine on the computer	Electronic	

13. COMPLETION OF SOWING

If there are seeds in container **1** after the sowing has been finished, place a vessel under the discharge chute of the container **2** (see Picture 50) and release the lid **3**. Use the turnstile door **4** for seeds that cannot be emptied using the discharge chute.

Picture 50 – Detail of emptying the container

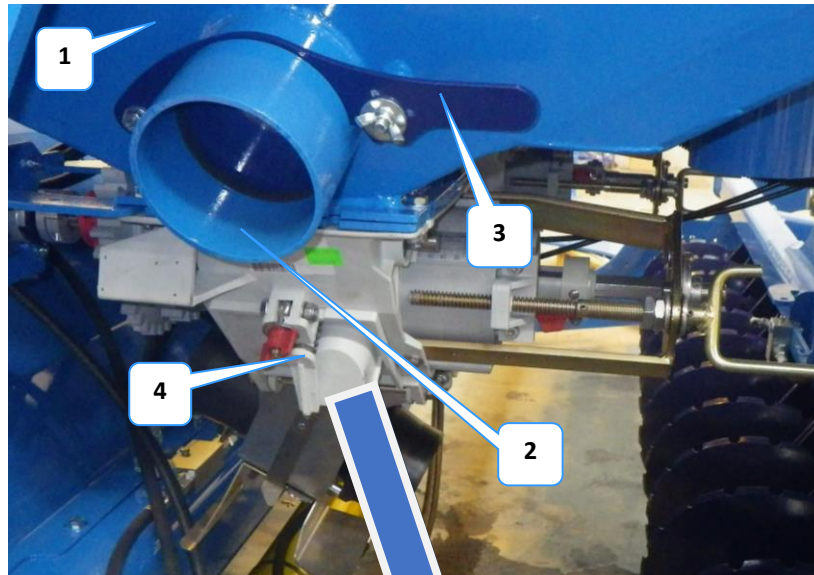

Clean of the doser roller



When you empty the container, we recommend “sowing” a few metres with the empty machine and running fan in order to remove the residues of seeds from the feeder and the whole system of the machine. Prompt removal of the seed residues, especially when you do not use the machine for a longer period of time, prolongs its usable life and prevents complications in the following operation.

14. MAINTENANCE AND REPAIRS OF THE MACHINE



Observe the safety instructions for maintenance and treatment.

- Only persons according to Chapter A.3/p. 6 may perform repairs of the machine. When leaving the tractor cabin, the operator must switch off all hydraulic circuits and appliances on the machine (ventilator) and the engine and the operator must prevent unauthorized access to the tractor.
- The replacement of worn discs can only be executed when the machine is standing still (not operating).
- If you have to use welding during a repair and have the machine connected to the tractor, make sure that all supply cables are disconnected from the alternator and accumulator.
- Check that all screws and other assembly points are tight before each use of the machine and whenever needed.
- Regularly check the wear and tear of the working parts of the machine or replace the worn working parts with new ones.
- Adjusting, cleaning and lubricating the machine may only be performed when the machine is standing still (the machine is stopped and is not working).
- When the machine is lifted, use an appropriate supporting device propped at designated places or at appropriate places.
- When adjusting, cleaning, maintaining and repairing the machine, secure those parts of the machine that could put the operator in danger by fall or other movement.
- Repairs of the hydraulic circuits may be performed only when the machine is unfolded and resting on the working bodies on the ground.
- When repairing the hydraulic circuits of the machine, first remove pressure from the hydraulic circuits of the machine with the use of control levers of the hydraulic system in the tractor cabin.
- For attaching the machine when manipulating it with the use of lifting equipment, use only places marked by stick-on labels with the symbol of a chain „“.
- If there is a defect or damage on the machine, immediately turn off the tractor engine and secure the machine against movement \Rightarrow then you can remove the defect.
- When repairing the machine, use only original spare parts, suitable tools and protective equipment.
- Check the prescribed pressure in the tyres of the machine and the condition of the tyres regularly. Execute potential repairs of tyres in a professional workshop.
- Keep the machine clean.



Do not use a high-pressure cleaner or direct water jet for cleaning hydraulic rolls (piston rod) and bearings and electronic parts. The bearings and seals are not waterproof under high pressure.





14.1. REPLACEMENT OF WORN DISCS

- When replacing discs, always observe safety regulations and directives.
- The machine must be aggregated with the tractor according to Chapter “3.1/P.13” for the replacement of the discs. The tractor engine must be switched off and the operator or the mechanic must prevent unauthorized access to the tractor.
- The machine must be lifted on the transport axle and in the arms of the tractor for the replacement of the discs.
- Raise the rear tractor TPS shoulders with the aggregated machine to the maximal position and secure it from falling. Then you may perform the replacement of worn shares.
- The ball valve of the axle must be in the “closed” position, see Picture 30/P.39. You must ensure mechanical supports under the pole of the machine in case the tractor hydraulic system is not tight.
- Only replace the discs on a firm and flat ground and when the machine is in standstill.

14.2. THE PRESSURE IN THE TYRES

Tab. 10

LUBRICATION POSITION		INTERVAL	LUBRICANT
Pole joint	Picture 51	1 x week *	Plastic lubricant K EP2 - 30 DIN 51 502
Bearings of axle	Picture 52	1 x year *	

*- Applies to the period when the machine is used on the field.

Picture 51 – Pole joint

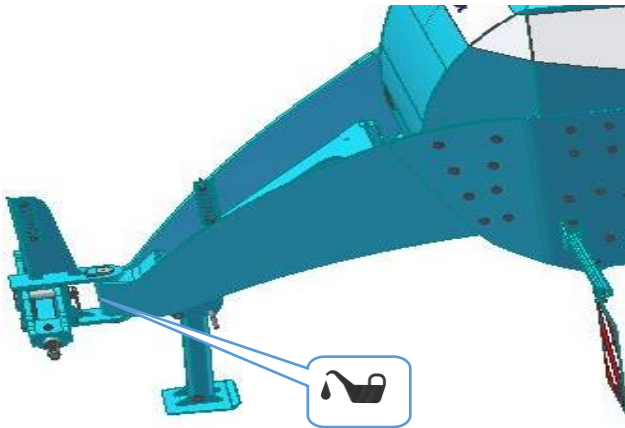

Picture 52 – Bearing of axle

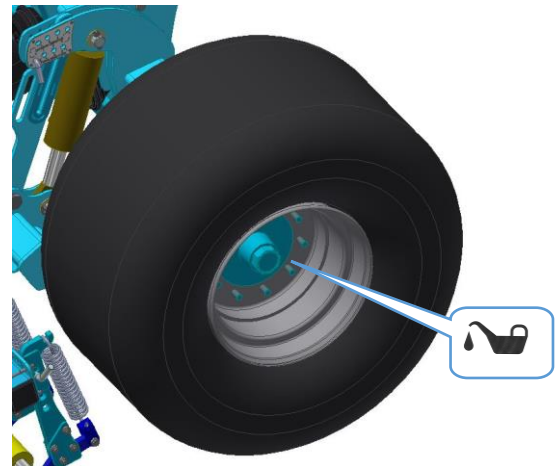

14.3. MANIPULATION WITH LUBRICANTS:

- Handle lubricants and oils as hazardous waste according to the valid acts and regulations.
- Protect yourself from direct contact with oils by using gloves or protective lotion.
- Wash oil stains on skin thoroughly with warm water and soap. Do not clean the skin with petrol, diesel oil or other dissolving agents.
- Oil is poisonous. If you swallow any, immediately seek a doctor.
 - Keep lubricants out of reach of children.

14.4. THE PRESSURE IN THE TYRES

RECOMMENDED TIGHTENING MOMENTS OF BOLTING

BOLTING	TIGHTENING MOMENT	NOTE
M8x1	8Nm	Fastening screws of house bearings
M8 (8.8)	25Nm	
M12 (8.8)	87Nm	Share screws
M16 (8.8)	210Nm	House bearings
M 20 (8.8)	50Nm	Rotary harrowing screws
M20 (8.8)	410Nm	Protection screws, axle rubber-tyred roller wheels
M24 (8.8)	710Nm	Hopper screws
HYDRAULIC + AIR JOINTS		
M16x1,5	60Nm	Hydraulic screwing, air screwing
M22x1,5	140Nm	Hydraulic screwing, air screwing

15. STORING THE MACHINE

When you put the machine out of operation for a longer-period of time:

- Store the machine under a roof, if possible.
- Store the machine on an even and solid ground with sufficient bearing capacity.
- Clean the machine before storing and make sure that the machine is not damaged during the storage. Pay special attention to all labelled lubricating places and lubricate the machine according to the lubrication plan.
- Store the machine with folded frames in the transport position. Leave the machine on the axle and the standing leg; secure the machine against movement with wedges or other suitable instruments.
- The machine must not be leaning on the discs as they may get damaged.
- Prevent access by unauthorized persons to the machine.

16. PROTECTION OF ENVIRONMENT

- Check the tightness of the hydraulic system regularly.
- Replace or repair hydraulic tubes or other parts of the hydraulic system showing signs of damage, before oil starts to leak.
- Check the condition of hydraulic tubes and execute their timely replacement. The usable life of hydraulic tubes also includes the storage time.
- Deal with oils and fats according to valid acts and regulations on wastes.

17. DISPOSAL OF THE MACHINE AFTER THE END OF ITS USABLE LIFE

- The operator must make sure that the steel parts and parts in which the hydraulic oil or lubricant is used are separated for disposal.
- The operator will cut the steel parts according to safety regulations and hand them over to the scrap yard for secondary raw materials. For other parts follow the valid acts on wastes.

18. MAINTENANCE AND TERMS OF GUARANTEE

18.1. MAINTENANCE

Maintenance is provided by a business representative after a consultation with the producer or by the producer. Spare parts are provided through the sales network of individual sellers all over the Czech Republic. Use only spare parts according to the Spare Parts Catalogue officially published by the producer.

18.2. GUARANTEE

- 18.2.1. The producer provides 24-month guarantee for the following parts of the machine: main frame, axle and pole of the machine. The producer provides 12-month guarantee for the remaining parts of the machine. The guarantee starts on the date of the sale of the new machine to the end consumer (user).
- 18.2.2. The guarantee applies to hidden defects that appear during the proper use of the machine during the guarantee period and according to the terms and conditions stated in the operating manual.
- 18.2.3. The guarantee does not apply to spare parts that can be worn out, i.e. to regular wear and tear of replaceable working parts (shares, blades etc.).
- 18.2.4. The guarantee does not apply to indirect consequences due to potential damage, such as decrease in the usable life etc.
- 18.2.5. The guarantee is related to the machine and does not cease to exist when the owner changes.
- 18.2.6. The guarantee is limited to disassembly and assembly, or replacement or repair of the faulty part. The contractual service of the company Farmet a.s. decides whether the faulty part will be replaced or repaired.
- 18.2.7. Only the authorized service technician of the producer may perform repairs or other interventions in the machine during the guarantee period, otherwise the guarantee will not be accepted. This provision does not apply to the replacement of spare parts that can be worn out (see Item 18.2.3).
- 18.2.8. The guarantee is conditioned by the use of original spare parts of the producer.

19. SPECIAL SPECIES OF SOWING

19.1. SETTING THE STRIP

This version means that we are sowing at a 250/300 pitch and this is achieved by disabling one single dosing engine (single sowing)

- The first step is to set the turnstile according to the calibration table.

CALIBRATION TABLES

Tab. 7b - Calibration table for regular seeds and sowing with fertilisation

CALIBRATION TABLE FOR SOWING SEEDS (APPROXIMATE VALUES) FOR THE FALCON SOWING MACHINES								
SEEDS	WHEAT	RYE	BARLEY	OATS	PEAS	MAIZE	MUSTARD	
Vol. mass kg/dm ³	0,77	0,74	0,68	0,5	0,81	0,79	0,6	
SEEDS - kg/ha FEEDER SETTING								
SCALE (mm)	5	X	X	X	X	X	X	5 - 7
	7	X	X	X	X	X	X	8 - 10
	10	X	X	X	X	X	X	11 - 15
	12	X	X	X	X	X	X	16 - 20
	15	X	X	X	X	X	X	21 - 25
	20	50	45	40	30	50	50	30
	30	80	75	70	60	80	80	X
	40	100	95	90	80	100	100	X
	45	120	115	110	100	120	120	X
	50	140	135	130	120	140	140	X
	55	160	155	150	140	160	160	X
	60	180	175	170	160	180	180	X
	65	200	195	190	180	200	200	X
	70	220	215	210	200	220	220	X
	75	240	235	230	220	240	240	X
	80	260	255	250	240	260	260	X
	85	280	275	270	260	280	280	X
90	300	295	290	280	300	300	X	
95	320	315	310	300	320	320	X	
100	340	335	330	320	340	340	X	

Fine Seeds

Tab. 8 – Sowing table for fine seeds

CALIBRATION TABLE FOR FINE SEEDS kg/ha						
SEEDS	RAPE	ROTKLLE	GRASS	PHACELIA	POPPY	
Vol. mass [kg/dm ³]	0,65	0,8	0,36	0,22	0,4	
FEEDER SETTING						
SCALE [mm]	4				0,5 – 1,5	
	5	1,5 - 2	5	x	x	1,5 - 2
	6	2,5	6	x	x	2
	7	3	7	x	x	2,5 - 3
	8	3,5	9	x	x	x
	9	4	12	4	x	x
	10	4,5	15	6	x	x
	11	5	20	7	x	x
	12	5,5	22	10	x	x
	13	6	25	14	x	x
	15	x	x	x	5 - 10	x
	17	x	x	x	11 - 15	x
	20	x	x	x	16 - 20	x

Attention!!!

When sowing fine seeds, use the fine roller (micro sowing) and pull out the red wheel.

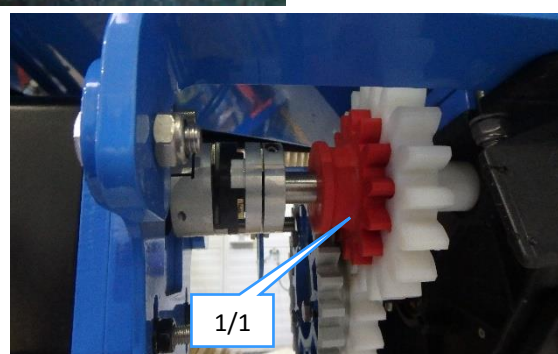
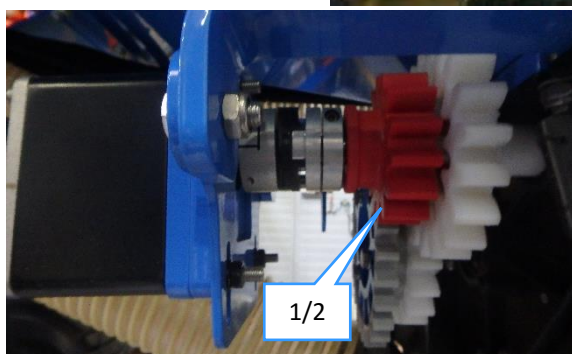

Picture 53 – Setting the feeder

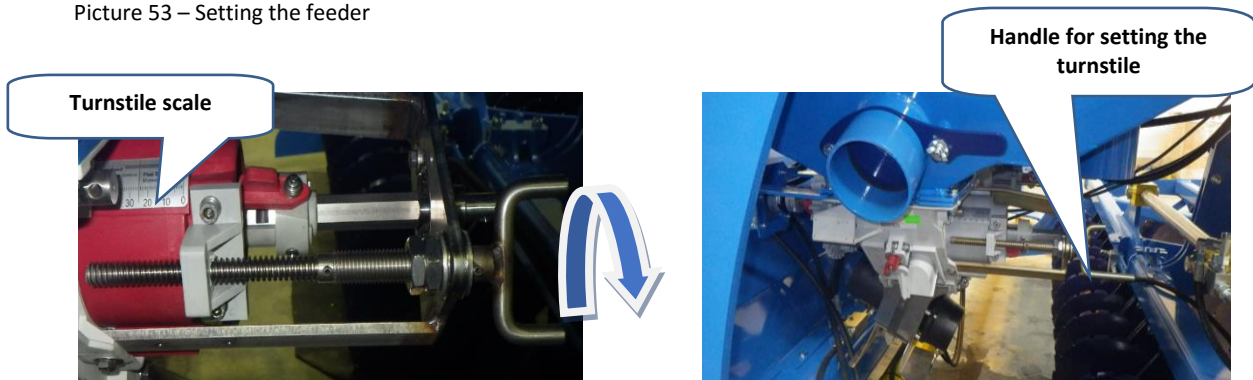

- The second step is to set the sowing dose in the electronic system:

In this case, we need to set the total required dose per product of 0kg / ha. We set the dispenser to be used at twice the desired dose. Example: The required dose is 50 kg / ha - the total required dose per product will be 0 kg / ha and the required dosage per doser will be set at 100 kg / ha.

! All shown in blue is selected by the rotary cursor on the side of the terminal !

Picture 54 - Adjustment of the sowing dose per seed dispenser per 50 kg / ha

Select the corresponding feeder (using the turning knob)

Here the calibration test (in this case for the seed)

Here, 0 kg / ha must always be entered

0.0 km/h	1
0 rpm	/ 1
SETTINGS	1 / 3
Seed 1	
Product	Seed 1
Target Rate	0.0 kg/ha
Speed	min. 0.5 max. 99.0 km/h

- The third step is the calibration test:

Picture 55 – Calibration test

Doser 1

0 km/h
0 rpm

CALIBRATION
1. Start

Metering Unit
1

Operating Speed
10.0 km/h

Target Rate
100.0 kg/ha

Calibration Factor
81 g/rotation

Speed
min. 1.6 max. 20.8 km/h

Fill up the feeder turnstile

Use this key to start the calibration test

Calibration factor	
Rape	5 g/rev.
Cereals	300 g/rev.
Legumes	300 g/rev.
Pea	400 g/rev.

Set what speed you will move during sowing

Set double the desired dose I ask 50 to set 100 kg / ha

Setting the approximate calibration factor depends on the seed type and its dose

Procedure – place a bag that have been weighed below the sowing mechanism. Blind the opening which will prevent the seeds from falling into the pipeline. Then press the key to start filling the bag with seeds.

Picture 56 – Filling the bag



By pressing this key you start filling the bag with seeds (hold until there is a weighable amount in the bag)

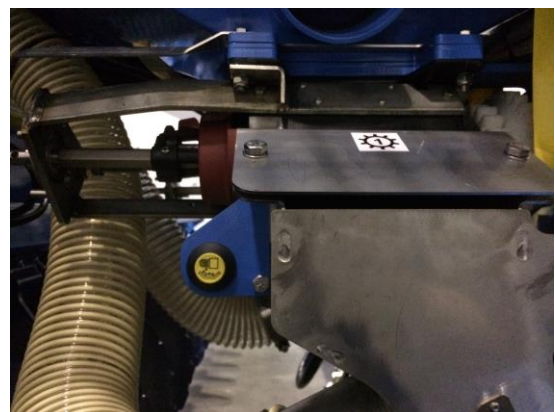

- The fourth step is to weigh the seed bag and enter the net seed weight into the imaging unit.

Picture 57 – Entering the weighed portion

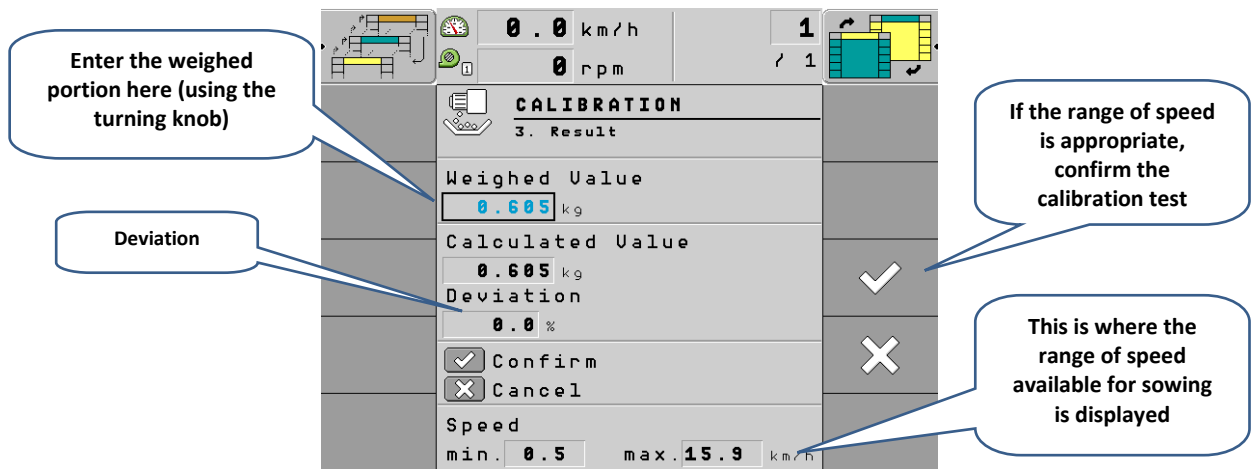

Picture 58 – Final calculation

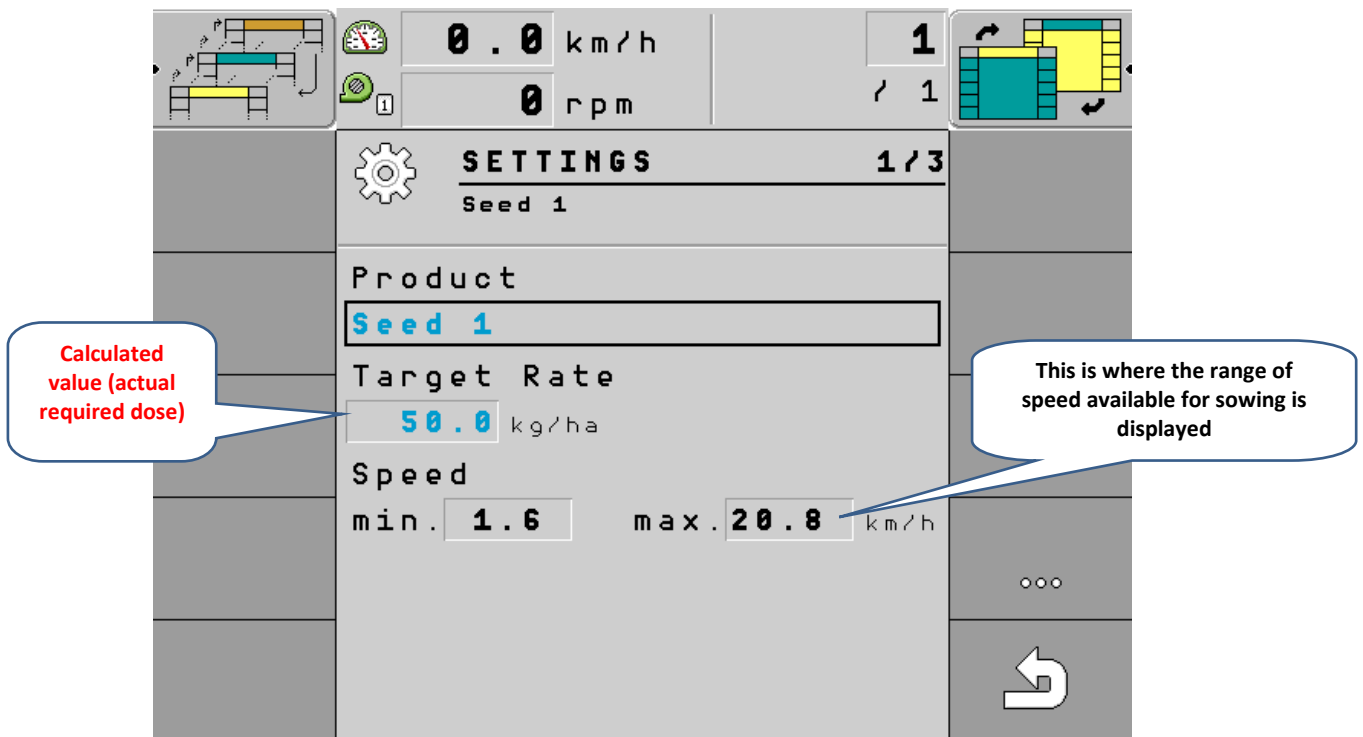

19.2. SOWING TWO DIFFERENT SEED OF SEEDS

This version means that we sow the entire machine width of two crops at the same time the harvesting organ (even / odd).

- The first step is to set the turnstile according to the calibration table.
- The second step is to set the sowing dose in the electronic system:

In this case, we need to set the total required dose to the product of 0kg / ha and set the dosing dose that we use to double the required dose. Example: The required dose is 50 kg / ha (buckwheat) 100 kg / ha (wheat) - the required dose per product will be 0 kg / ha and the required dose per doser will be 100kg / ha (buckwheat) and 200kg / ha (wheat).

! All shown in blue is selected by the rotary cursor on the side of the terminal !

Picture 59 – Sowing setting for one seed doser per 100 kg / ha

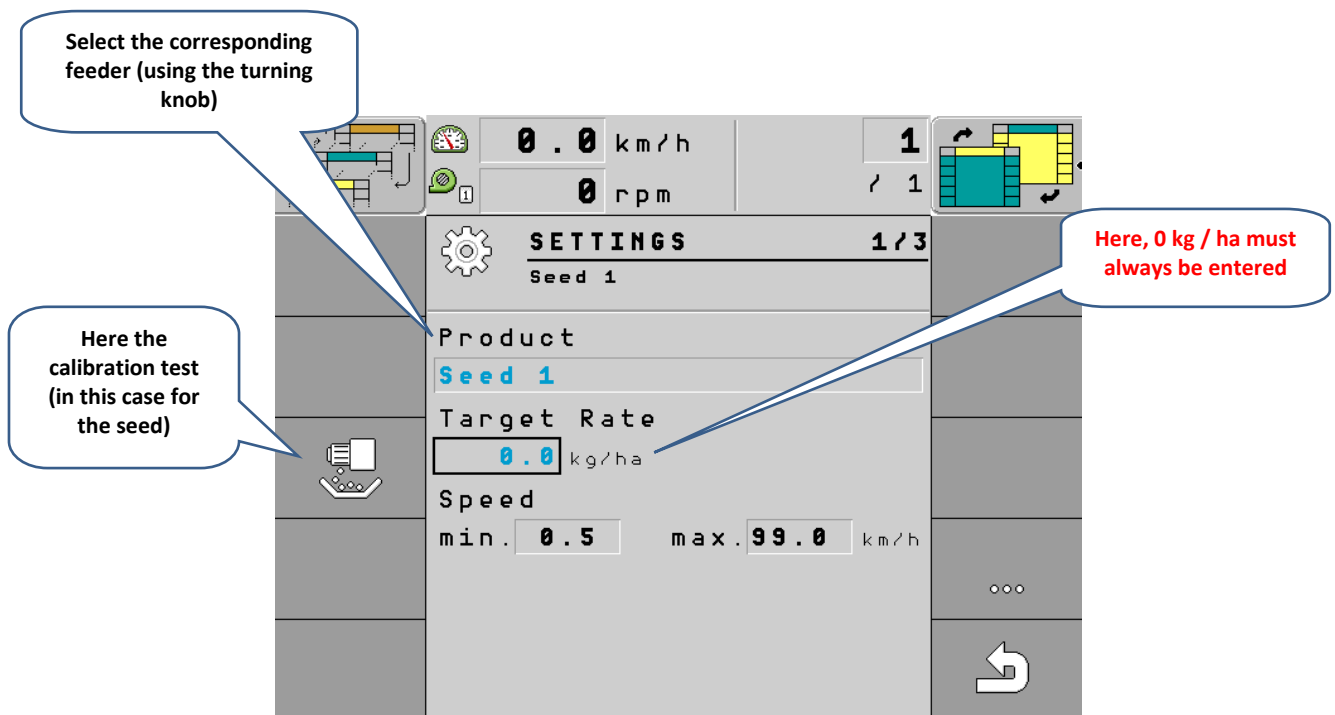

- Third step is calibration test

Picture 60 – Calibration test

Set what speed you will move during sowing

Set double the desired dose

Setting the approximate calibration factor depends on the seed type and its dose

Doser 1

0 km/h
0 rpm

CALIBRATION
1. Start

Metering Unit
1

Operating Speed
10.0 km/h

Target Rate
100.0 kg/ha

Calibration Factor
81 g/rotation

Speed
min. 1.6 max. 20.8 km/h

Fill up the feeder turnstile

Use this key to start the calibration test

Calibration factor	
Rape	5 g/rev.
Cereals	300 g/rev.
Legumes	300 g/rev.
Pea	400 g/rev.

Procedure – place a bag that have been weighed below the sowing mechanism. Blind the opening which will prevent the seeds from falling into the pipeline. Then press the key to start filling the bag with seeds.

Picture 61 – Filling the bag



By pressing this key you start filling the bag with seeds (hold until there is a weighable amount in the bag)

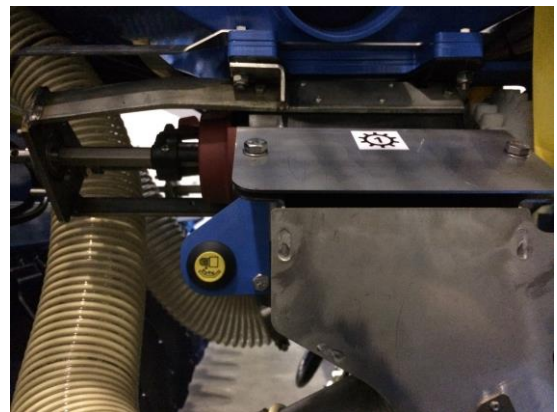

- The fourth step is to weigh the seed bag and enter the net seed weight into the imaging unit.

Picture 62 – Entering the weighed portion

Enter the weighed portion here (using the turning knob)

Deviation

If the range of speed is appropriate, confirm the calibration test

This is where the range of speed available for sowing is displayed

0.0 km/h
0 rpm

CALIBRATION
3. Result

Weighed Value
0.605 kg

Calculated Value
0.605 kg

Deviation
0.0 %

Confirm
 Cancel

Speed
min. 0.5 max. 15.9 km/h

- The fifth step is to set the second dispenser

Picture 63 – Set up the second doserr

Doser 2

0 km/h
0 rpm

CALIBRATION
1. Start

Metering Unit
2

Operating Speed
10.0 km/h

Target Rate
200.0 kg/ha

Calibration Factor
124 g/rotation

Speed
min. 0.5 max. 15.9 km/h

Set what speed you will move during sowing

Set double the desired dose

Setting the approximate calibration factor depends on the seed type and its dose

Fill up the feeder turnstile

Use this key to start the calibration test

Procedure – place a bag that have been weighed below the sowing mechanism. Blind the opening which will prevent the seeds from falling into the pipeline. Then press the key to start filling the bag with seeds.

Picture 64 – Filling the bag



By pressing this key you start filling the bag with seeds (hold until there is a weighable amount in the bag)

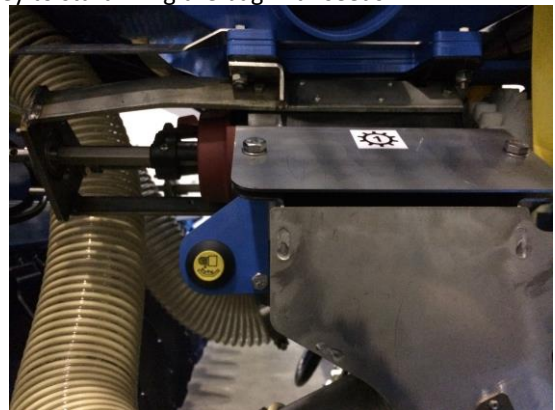

- The sixth step is to weigh the seed bag and enter the net seed weight into the imaging unit.

- The seventh step is the final calculation, the calculated dose is the average of the two dosers, 50kg / ha (buckwheat), 100kg / ha (wheat) = 150kg / ha

0.0 km/h
0 rpm

SETTINGS 1/3

Seed 1

Product
Seed 1

Target Rate
150.0 kg/ha

Speed
min. 1.6 max. 15.9 km/h

ADDENDUM:

Joined control of hydraulic circuits when there is insufficient number of circuits on the tractor.

1. Lifting of the front section is connected to lifting of the sowing section and it is controlled jointly.
2. The circuits of the control of front leveller and pressure of the drill coulters are connected using a ball valve. By changing the position of the ball valve, you change the function that is activated. The setting procedure for work is:
 - First set the pressure of the drill coulters at the required value
 - Then switch the valve to front leveller control. This allows controlling the front leveller when driving. On the other hand, the pressure of the drill coulters cannot be changed when driving.
 - After work, switch the valve to drill coulters pressure control and lift the drill coulters in the transport position.



LOCATION OF THE SWITCHING VALVE

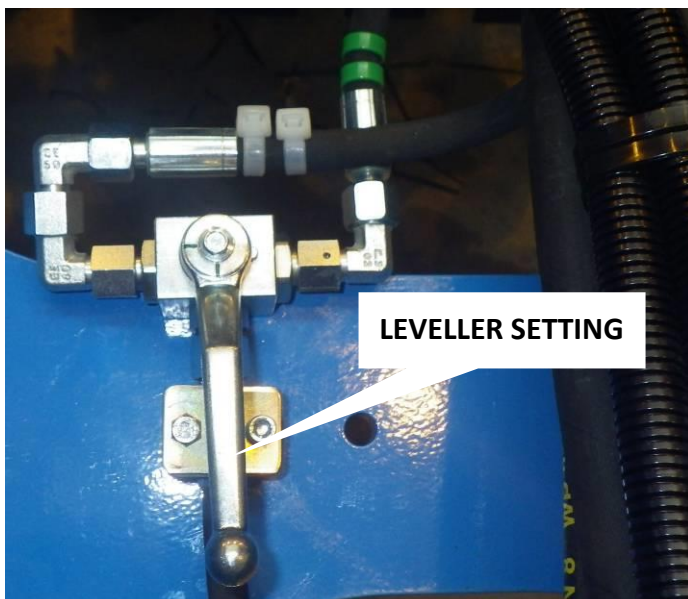

LEVELLER SETTING

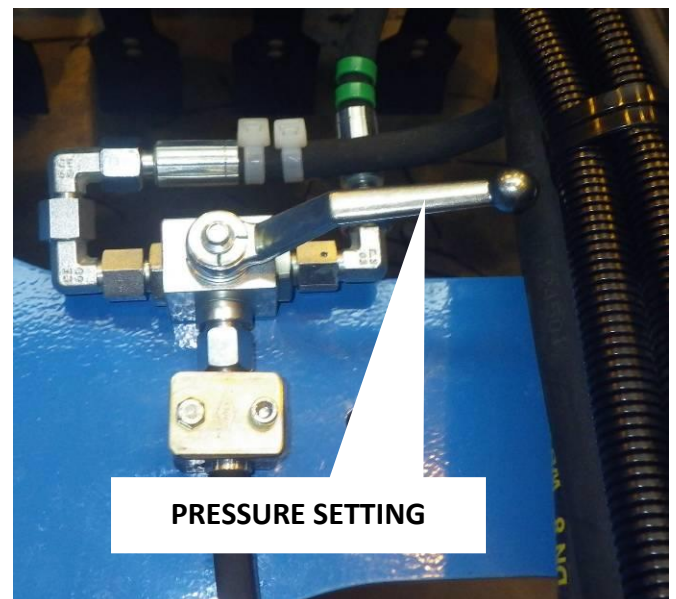

PRESSURE SETTING

20. STRATEGIC SPARE PARTS

- The below table lists all the components without which it is not possible to work with Falcon.

COMPONENT NAME	COMPONENT IDENTIFICATION	QUANTITY
Fan sensor	m14264	1
Dispenser sensor	m13836	1
Fan coupling	m08393	1
Fan sealing	m13039	1
Pressure sensor	m10190	1
Antenna sensor	m09740	1
Radar	m13835	1
Seed rate sensor	m14040	1
Track line flap	m08729	1



Report on the Delivery of the Machine and Putting into Operation

Type of machine:

Serial number of the machine:

Date of delivery and putting into operation:

The following workers were familiarised with the machine, complete instructions for use and maintenance and terms of guarantee:

Name and surname	Function	Signature
1.		
2.		
3.		
4.		

The following documents were delivered with the machine:

Log book	YES	NO
Operating manual	YES	NO
Spare parts catalogue	YES	NO

Other documents.....

The guarantee will not be accepted if the machine is operated by other persons than those stated in this report or if there have been any interventions in the machine that are not determined by the instructions for use!!!

The machine was delivered with all parts according to the purchase contract, functional and undamaged.

Delivered by (name and surname, function)
function)

Accepted by (name and surname,

Stamp, date and signature

Stamp, date and signature

Send the completed document together with a copy of the letter of guarantee within 5 days since the machine has been put into operation as a registered letter to the address of the producer. The document is groundwork for accepting guarantee.

Farmet a. s.
Jiřinková 276
ČESKÁ SKALICE 552 03



Phone.: +420 491 450 140
Fax.: +420 491 450 136
GSM.: +420 774 715 738

LETTER OF GUARANTEE

MACHINE MODEL:

YEAR OF PRODUCTION/SERIAL NUMBER: _____

TECHNICAL INSPECTION: _____

BUYER (ADDRESS): _____

SELLER (ADDRESS): _____

GUARANTEE TERMS AND CONDITIONS:

- I. The producer provides 24-month guarantee for the following parts of the machine: main frame, axle and pole of the machine. The producer provides 12-month guarantee for the remaining parts of the machine. The guarantee starts on the date of the sale of the new machine to the end consumer (user).
- II. The guarantee applies to hidden defects that appear during the proper use of the machine during the guarantee period and according to the terms and conditions stated in the operating manual.
- III. The guarantee does not apply to spare parts that can be worn out, i.e. to regular wear and tear of replaceable working parts (shares, blades etc.).
- IV. The guarantee does not apply to indirect consequences due to potential damage, such as decrease in the usable life etc.
- V. The guarantee is related to the machine and does not cease to exist when the owner changes.
- VI. The guarantee is limited to disassembly and assembly, or replacement or repair of the faulty part. The contractual service of the company Farmet a.s. decides whether the faulty part will be replaced or repaired.
- VII. Only an authorized service technician of the producer may perform repairs or other interventions in the machine during the guarantee period, otherwise the guarantee will not be accepted. This provision does not apply to the replacement of spare parts that can be worn out (see Item III).
- VIII. The guarantee is conditioned by the use of original spare parts of the producer.

MANUFACTURER

SELLER

DATE

DATE OF THE FIRST SALE

2016/002/01

☐^{CZ} ES PROHLÁŠENÍ O SHODĚ
☐^{GB} CE CERTIFICATE OF CONFORMITY
☐^D EG-KONFORMITÄTSERKLÄRUNG
☐^F DÉCLARATION CE DE CONFORMITÉ
☐^{RU} СЕРТИФИКАТ СООТВЕТСТВИЯ ЕС
☐^{PL} DEKLARACJA ZGODNOŚCI WE

1. ☐^{CZ} My ☐^{GB} We ☐^D Wir ☐^F Nous ☐^{RU} Мы ☐^{PL} My: **Farmet a.s.**
Jiřinková 276
552 03 Česká Skalice
Czech Republic
DIČ: CZ46504931
Tel/Fax: 00420 491 450136

☐^{CZ} Vydáváme na vlastní zodpovědnost toto prohlášení. ☐^{GB} Hereby issue, on our responsibility, this Certificate. ☐^D Geben in alleiniger Verantwortung folgende Erklärung ab. ☐^F Publiions sous notre propre responsabilité la déclaration suivante. ☐^{RU} Под свою ответственность выдаем настоящий сертификат. ☐^{PL} Wydajemy na własną odpowiedzialność niniejszą Deklarację Zgodności.

2. ☐^{CZ} Strojní zařízení: - název : **Diskový sečí stroj**
☐^{GB} Machine: - name : **Disc sowing machine**
☐^D Fabrikat: - Bezeichnung : **Scheibensämaschine**
☐^F Machinerie: - dénomination : **Semeuse à disques**
☐^{RU} Сельскохозяйственная машина: - наименование : **Дисковая сеялка**
☐^{PL} Urządzenie maszynowe: - nazwa : **Siewnik talerzowy**

- typ, type : **FALCON**
- model, modèle : **FALCON SW**
- ☐^{CZ} výrobní číslo :
- ☐^{GB} serial number :
- ☐^D Fabriknummer :
- ☐^F n° de production :
- ☐^{RU} заводской номер :
- ☐^{PL} numer produkcyjny:

3. ☐^{CZ} Příslušná nařízení vlády: č.176/2008 Sb. (směrnice 2006/42/ES). ☐^{GB} Applicable Governmental Decrees and Orders: No.176/2008 Sb. (Directive 2006/42/ES). ☐^D Einschlägige Regierungsverordnungen (NV): Nr.176/2008 Slg. (Richtlinie 2006/42/ES). ☐^F Décrets respectifs du gouvernement: n°.176/2008 du Code (directive 2006/42/CE). ☐^{RU} Соответствующие постановления правительства: № 176/2008 Сб. (инструкция 2006/42/ES). ☐^{PL} Odpowiednie rozporządzenia rządowe: nr 176/2008 Dz.U. (Dyrektywa 2006/42/WE).

4. ☐^{CZ} Normy s nimiž byla posouzena shoda: ☐^{GB} Standards used for consideration of conformity: ☐^D Das Produkt wurde gefertigt in Übereinstimmung mit folgenden Normen: ☐^F Normes avec lesquelles la conformité a été évaluée: ☐^{RU} Нормы, на основании которых производилась сертификация: ☐^{PL} Normy, według których została przeprowadzona ocena: ČSN EN ISO 12100, ČSN EN ISO 4254-1, ČSN EN 14018+A1.

☐^{CZ} Schválil ☐^{GB} Approve by dne: 01.07.2016
☐^D Bewilligen ☐^F Approuvé
☐^{RU} Утвердил ☐^{PL} Uchwalił

Ing. Tomáš Smola
technický ředitel
Technical director

Farmet a.s.
Jiřinková 276
552 03 Česká Skalice
DIČ CZ46504931
59

V České Skalici dne: 01.07.2016

Ing. Karel Žďárský
generální ředitel společnosti
General Manager