

OPERATING MANUAL

KOMPAKTOMAT

K1250PS | K1570PS

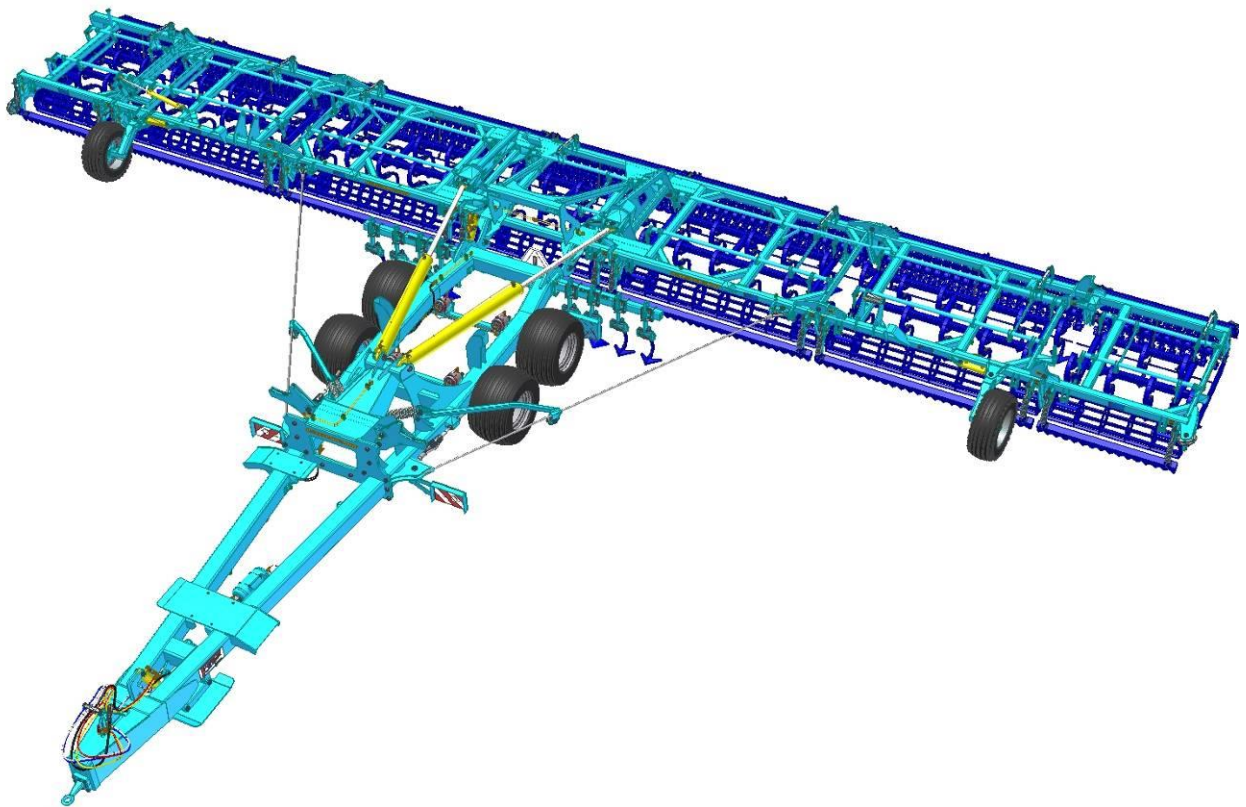

Edition: 5 | effective from: 1. 1. 2021

Dear customer,

Semi-carried machines **KOMPAKTOMAT** are quality products of Farmet a.s. Česká Skalice.

You can fully utilise the advantages of your machine after thoroughly studying the operating manual.

The serial number of the machine is punched on the production label and written in the operating manual (see Tabl.1). This machine serial number must be stated whenever ordering spare parts for possible repairs. The production label is located on the middle frame near the tow bar.

Use only original spare parts for these machines according to the **Spare parts catalogue** officially issued by the manufacturer, Farmet a.s. Ceska Skalice.

Possibilities of Use of Your Machine

Kompaktomat is intended for presowing preparation of soil as a subsequent operation after ploughing or stubble breaking. The machine is intended for tractors with the output of 243-316 kW (See Chapter **E.3**/Page 5-6). Optimal speed for soil processing is 8-12 km/hour.

Tabl. 1- Characteristics of the machine

TYPE OF MACHINE	
SERIAL NUMBER OF MACHINE	
SPECIAL VERSION OR ACCESSORIES:	
.....	
.....	
.....	
.....	
.....	

CONTENTS

A.	LIMITING PARAMETERS	4
B.	MACHINE TRANSPORT USING TRANSPORT MEANS	5
C.	MACHINE HANDLING USING LIFTING EQUIPMENT	5
D.	ASSEMBLY AT THE CUSTOMER'S PLACE	5
E.	AGREGATION WITH THE TRACTOR	5
F.	FOLDING AND UNFOLDING THE MACHINE.....	6
G.	ROAD TRANSPORTATION.....	6
H.	OPERATING THE MACHINE IN THE FIELD	7
I.	MACHINE ADJUSTMENT	7
J.	STORAGE.....	7
K.	MACHINE REPAIRS.....	8
L.	REPLACEMENT OF WORN-AND-TORN SHARES	8
M.	MACHINE DISPOSAL AFTER ITS SERVICE LIFE	8
1.	MACHINE DESCRIPTION.....	12
1.1	Aggregation to a tractor	12
1.2	Working parts	12
2.	SPECIFICATIONS.....	16
3.	OPERATIONAL SAFETY RULES	17
4.	ROAD TRANSPORT RULES	17
5.	SETTING TO WORK	18
6.	AGREGATION WITH THE TRACTOR	22
7.	PROCEDURE FOR UNFOLDING INTO THE WORKING POSITION.....	22
8.	PROCEDURE FOR FOLDING INTO THE TRANSPORT POSITION.....	25
9.	ADJUSTING THE WORKING PARTS OF THE MACHINE.....	27
9.1	Adjusting the position and depth of the track cultivators.....	28
9.2	Adjusting the spring mounted front leveller	29
9.2.1	FL + FH – Front fixed serrated levelling bar.....	30
9.3	Adjusting the components of RING rollers	30
9.4	Adjusting the depth of the share section	31
9.4.1	MCD-mechanical depth setting.....	32
9.4.2	HD-hydraulic depth setting	32
9.5	Adjusting the leveller height behind shares	32
9.6	Setting the finishing section features	33
9.6.1	Setting the angle of the rear leveller.....	33
9.6.2	Setting the pressure of the finishing roller.....	33
9.7	Pre-stressing tractive ropes	34
10.	FIELD WORK POSSIBILITIES FOR THE MACHINE.....	35
11.	BRAKE DISTRIBUTION OF THE MACHINE	37
12.	EXCHANGING THE WORKING TOOLS.....	37
12.1	Replacement of the working roller bearings	37
12.1.1	Using spacer.....	38
13.	MAINTENANCE AND REPAIRS.....	39
14.	LUBRICATION PLAN FOR THE MACHINE	43
15.	ENVIRONMENTAL PROTECTION.....	44
16.	MACHINE DISPOSAL AFTER SERVICE LIFE EXPIRY	44
17.	SERVICES AND WARRANTY CONDITIONS	44

A. LIMITING PARAMETERS

- A.1** ⁽¹⁾ Operator(s) may use the machine for agricultural purposes only as an exchangeable implement aggregated with a tractor.
- A.2** ⁽²⁵⁾ Operator(s) may use the machine only for soil preparation before sowing as a follow-up operation after ploughing or stubble ploughing in the field.
- A.3** ⁽³⁾ Operator(s) must not use the machine for other purposes, especially:
- ⁽⁴⁾ Transporting persons on the machine,
 - ⁽⁵⁾ Transporting loads on the machine,
 - ⁽⁶⁾ Aggregating the machine with a towing vehicle other than that mentioned in Chapter „E.3“.
- A.4** ⁽⁷⁾ Machine operation may be performed by a person authorised by the operator under these conditions:
- ⁽⁸⁾ It must own a valid driver's licence of the corresponding category,
 - ⁽⁹⁾ It must be demonstrably familiarised with the safety regulations for work with the machine and must practically master the machine operation,
 - ⁽¹⁰⁾ The machine may not be operated by juveniles,
 - ⁽¹¹⁾ It must know the meaning of the safety signs located on the machine. Their respecting is important for safe and reliable machine operation.
- A.5** ⁽¹²⁾ Maintenance and servicing repairs on the machine may only be performed by a person:
- ⁽¹³⁾ Authorised by the operator,
 - ⁽¹⁴⁾ Educated in the machinery field with knowledge of repairs of similar machines,
 - ⁽¹⁵⁾ Demonstrably familiarised with safety regulations for work with the machine,
 - ⁽¹⁶⁾ During a repair of a machine connected to a tractor, it must own a driver's licence of the corresponding category.
- A.6** ⁽¹⁷⁾ Machine operator must secure the safety of other persons when working with the machine or transporting the machine.
- A.7** ⁽¹⁸⁾ During machine work in the field or during transport, the operator must control the machine from the tractor's cabin.
- A.8** ⁽¹⁹⁾ The operator may enter the machine structure only with the machine at rest and blocked against movement, namely only for these reasons:
- ⁽²⁰⁾ Adjustment of the machine working parts,
 - ⁽²¹⁾ Repair and maintenance of the machine,
 - ⁽²⁹⁾ Release and securing of spherical valves of the axle,
 - ⁽²⁷⁾ Securing of spherical valves of the axle before folding the side frames,
 - ⁽²⁸⁾ Adjustment of the working parts of the machine after unfolding the side frames.
- A.9** ⁽²²⁾ Any changes or modifications of machine may be performed only with written consent of the manufacturer. For possible damage arisen due to ignoring this instruction, the producer bears no responsibility. The machine must be maintained equipped with prescribed accessories and equipment including safety marking. All warning and safety signs must be legible and in their places. In case of damage or loss, these signs must be immediately renewed.
- A.10** ⁽²³⁾ The operator must have the Operating Manual with the work safety requirements available at any time when working with the machine.
- A.11** ⁽²⁴⁾ The operator must not consume alcohol, medicines, narcotic and hallucinogenic substances that decrease his attention and coordination capabilities while using the machine. If the operator must use medicines prescribed by a physician or uses freely sold medicines, he must be informed by a physician, whether he is capable of responsible and safe operation of the machine under these circumstances.

B. MACHINE TRANSPORT USING TRANSPORT MEANS

- B.1** ⁽¹⁾ The transport means designed for machine transport must have the load capacity minimally identical with the weight of the transported machine. The total weight of the machine is stated on the production label.
- B.2** ⁽²⁾ The dimensions of the transported machine including the transport means must comply with the valid regulations for road traffic (decrees, laws).
- B.3** ⁽³⁾ The transported machine must be always fastened to the transport means so that its spontaneous loosening could not happen.
- B.4** ⁽⁴⁾ The carrier is responsible for damage caused by the loosening of incorrectly or insufficiently fastened machine to the transport means.
- B.5** ⁽⁵⁾ If transported on another vehicle, the machine must be disassembled.

C. MACHINE HANDLING USING LIFTING EQUIPMENT

- C.1** ⁽¹⁾ The lifting equipment and tying means designed for handling of the machine must have their load capacity at least identical with the weight of the handled machine.
- C.2** ⁽²⁾ Machine fastening for handling may only be performed in places designed for that and marked with self-adhesive labels showing the "chain" symbol. 
- C.3** ⁽³⁾ After fastening (suspending) at designated points, it is forbidden to move in the space of possible reach of the handled machine.

D. ASSEMBLY AT THE CUSTOMER'S PLACE

- D.1** ⁽¹⁾ The operator should assemble the machine according to the manufacturer's instructions. Cooperation with a serviceman/technician authorized by the manufacturer is advisable.
- D.2** ⁽²⁾ After the assembly is completed, the operator should ensure that all the assembled parts are functional and work smoothly
- D.3** ⁽³⁾ The operator should ensure that handling the machine by using the hoisting mechanism when assembling it is in compliance with Chapter „C“ above.

E. AGREGATION WITH THE TRACTOR

- E.1** ⁽¹⁾ The operator must observe all general labour-safety, fire-protection and environmental regulations.
- E.2** ⁽²⁾ The operator may hitch up the machine solely to such a tractor that is provided with a rear three-point suspension and a functional undamaged hydraulic system.
- E.3** ⁽³⁾ Towing vehicle requirements.

⁽⁵⁾ Tractor Engine Output Requirements ⇒ for K 1250 PS	243 kW	
⁽⁵⁾ Tractor Engine Output Requirements ⇒ for K 1570 PS	316 kW	
^(xx) Tractor three-point suspension requirements	^(xx) Ø of the lower hitch bolt	Ø50 mm
	^(xx) lower hitch height	480 - 550 mm
⁽⁹⁾ Tractor hydraulic system requirements	^(xx) side frame unfolding and trail cultivator recess control circuit	The pressure in the circuit: 200 bar, two ISO 12.5 quick coupler sockets

	(xx) catch and tracing wheel control circuit	The pressure in the circuit: 200 bar, two ISO 12.5 quick coupler sockets
	(xx) position of the track cultivators control circuit	The pressure in the circuit: 200 bar, two ISO 12.5 quick coupler sockets
	(xx) supporting leg control circuit	The pressure in the circuit: 200 bar, two ISO 12.5 quick coupler sockets
	(xx) K 1570 PS side frame unfolding circuit	The pressure in the circuit: 200 bar, two ISO 12.5 quick coupler sockets
(12) Tractor air system requirements	(13) The machine axle brake circuit	(16) The pressure in the circuit: min.6 bar – max. 8 bar, one single-circuit brake coupling head

- E.4** (xx) Before aggregating the machine with the tractor (especially with those not provided with a quick suspension device), the operator must secure the tractor against undesirable movement. Especially with tractors not provided with a quick suspension device, the operator should arrange for another trained person to cooperate. Such a person must not step into the suspension area before the tractor is secured against undesirable movement. With tractors provided with a quick suspension device, this operation can be made by the operator from the tractor driver's seat.
- E.5** (17) Aggregating the hydraulic system of the machine with the hydraulic system of the tractor should be performed according to Chapter 5 of this Operating manual.

F. FOLDING AND UNFOLDING THE MACHINE

- F.1** (xx) Operator(s) must ensure that no person or animal is within the reach of the lateral frames when folding and/or unfolding them. Nobody should insert the fingers into the joint space.
- F.2** (xx) Before unlocking the connecting rod, the operator(s) must secure the set against undesirable motion and check (from the tractor cab) by using the hydraulic system control levers whether or not there is oil in the piston rods. Only after the operator is sure that there is oil in the piston rod, may he proceed to unlocking the connection rod.

G. ROAD TRANSPORTATION

- G.1** (1) The transportation speed of the tractor with the machine should not exceed the maximum transport speed and the maximum slope accessibility indicated.
- G.2** (2) When transported on public roads, increased guardedness should be observed due to the machine dimensions.
- G.3** (3) When transporting on public roads the machine should be provided with a functional set of warning lights that must be on. If possible, the highest point of the set (usually the tractor roof) should be provided with a yellow flashing beacon. Moreover, the machine should be provided with the "maximum-speed" sign, with red-and-white-hatched boards at the machine contours and with rear reflectors and reflecting board according to the respective regulations.
- G.4** (6) The machine should not be transported at poor visibility.

- G.5** ⁽⁷⁾ Note that the driving properties of the set change when towed by a tractor on the road due to different axle loads. Please have this in mind when transporting the machine. The respective road-transport rules should be strictly observed.
- G.6** ⁽⁸⁾ The operator is obliged to produce the respective certificate of roadworthiness (the MOT Certificate) if necessary.
- G.7** ⁽⁹⁾ When transporting the machine on public roads, all the respective traffic rules and traffic signs should be observed.
- G.8** ⁽¹⁰⁾ When making U-turns or driving reverse gear, be especially careful. Ensure a good outlook from the tractor cab and use another (instructed and authorized) person if necessary.
- G.9** ⁽¹¹⁾ When transporting the machine off public roads, operator(s) should not exceed the lowest maximum transport speed and the lowest maximum slope accessibility indicated wherever on the set.
- G.10** ^(xx) The operator must secure the folded side frames by the connecting rod to prevent their unfolding before the start of transportation on ground communications.

H. OPERATING THE MACHINE IN THE FIELD

- H.1** ⁽¹⁾ The operator should acquaint himself with the machine controls before the first use of the machine.
- H.2** ⁽²⁾ Before setting the machine to work, please read the Instructions for use carefully. Pay attention to labour protection, safe operation and transportation, environmental protection, setting the machine and its maintenance.
- H.3** ⁽³⁾ The operator is responsible for all damages incurred by improper operation of the tractor and the coupled machine.
- H.4** ⁽⁴⁾ When operating the machine, the operator is obliged to observe all the technical and safety regulation set by the manufacturer.
- H.5** ⁽⁶⁾ When operating the machine, the operator should observe the prescribed working depths and speeds given in Chapter 2/Page 16 of this manual.
- H.6** ⁽⁷⁾ When leaving the tractor cab, the operator is obliged to lower the machine onto the ground and secure it against undesirable motion.

I. MACHINE ADJUSTMENT

- I.1** ⁽¹⁾ When adjusting the working tools of the machine, the operator should follow the values recommended in Chapter 9/Pages 27 to 34. Please observe the labour safety principles.
- I.2** ⁽²⁾ The machine working tools may be adjusted at rest only with the machine secured against undesirable motion.
- I.3** ⁽³⁾ Working tools adjustments should be done on a flat and paved surface so that the soil cultivation is performed evenly.

J. STORAGE

- J.1** ⁽¹⁾ Before storing the machine, the machine should be thoroughly cleaned and preserved in such a manner that no damage can occur. Special attention should be paid to all the lubrication points indicated. These points should be lubricated thoroughly according to the Lubrication Chart, see Chapter 14./Page 43.

J.2 ^(xx) It is recommended to store the machine in the transport position, i.e. the side frames folded and secured by the connecting rod and the machine resting on the supporting leg. The operator must secure the stored machine from spontaneous movement by activating the hand brake of the machine.

J.3 ⁽³⁾ The operator is obliged to secure the storage place against unauthorized persons' entrance.

K. MACHINE REPAIRS

K.1 ⁽¹⁾ Servicing and maintaining the machine can only be carried out by qualified persons duly authorized by the operator, see Chapter **A.4**.

K.2 ⁽²⁾ Any machine repairs may only be made at rest, i.e. the machine does not work. If it is necessary for the machine to be coupled with the tractor during the repair, the ignition key must be removed from the switchbox.

K.3 ⁽⁵⁾ All kinds of the machine hydraulic circuit repairs may only be made under the following conditions:

- ⁽⁶⁾ The lateral frames are unfolded,
- ⁽⁷⁾ The machine must rest on the shares and rollers;
- ⁽⁸⁾ The machine must be secured against undesirable motion;
- ⁽⁹⁾ The machine hydraulic circuit must be disconnected from the tractor hydraulic circuit;
- ⁽¹⁰⁾ The machine vicinity must be protected from being contaminated by hydraulic oil;
- ⁽¹¹⁾ The machine must not rest on the axle.

K.4 ⁽³⁾ Any machine repairs should be made in service shops.

K.5 ⁽¹²⁾ Before repairing the machine hydraulic circuits, the repairman must eliminate pressure in the hydraulic circuits with the control levers in the tractor cab. This should be done by moving the levers to their extreme positions back and forth (approx. five times) with the tractor engine stopped.

K.6 ⁽⁴⁾ When handling the machine with a lifting device, the regulations set forth in Chapter **C** should be strictly observed.

L. REPLACEMENT OF WORN-AND-TORN SHARES

L.1 ^(xx) The operator or the serviceman must observe generally valid safety regulations during any replacement of working bodies.

L.2 ⁽¹⁾ The shares should be replaced by the serviceman or operator on a flat and paved surface only.

L.3 ⁽²⁾ When replacing the shares, the machine must be aggregated with the tractor according to Chapter **E**. When replacing the shares, the tractor engine must be stopped and the tractor cab secured against unauthorized entrance or operation.

L.3 ⁽⁵⁾ If there is a leakage from the tractor hydraulic system, the repairing person is obliged to support the machine shaft mechanically.

M. MACHINE DISPOSAL AFTER ITS SERVICE LIFE

M.1 ^(xx) The owner shall observe generally valid safety regulations in case of any disposal.

M.2 ⁽¹⁾ The operator must ensure that the machine is secured against undesirable motion before starting the disposal operations.

M.3 ⁽²⁾ The operator must ensure that metal parts are separated from those parts that contain hydraulic oil or grease.

- M.4 ⁽³⁾ Steel parts must be cut up and delivered to the respective salvage point. The other secondary raw materials should be disposed according to the applicable waste management regulations.
- M.5 ⁽⁴⁾ The operator should ensure that handling the machine with the lifting device is in compliance with Chapter C.
- M.6 ⁽⁵⁾ Before disposing the machine hydraulic circuits, the repairman must eliminate pressure in the hydraulic circuits with the control levers in the tractor cab. This should be done by moving the levers to their extreme positions back and forth (approx. five times) with the tractor engine stopped.

N. LABOUR-PROTECTION STICKERS

The labour-protection stickers protect operators.

Generally:

- A) Strictly adhere to the labour-protection stickers instructions.
 - B) All the labour-protection stickers instructions apply to other users as well.
 - C) In case of damaging or destroying a LABOUR-PROTECTION STICKER located on the machine, operators are obliged to REPLACE IT OR PROVIDE THE MACHINE WITH A NEW ONE IMMEDIATELY.
- The position, design and exact meaning of the labour-protection stickers located on the machine are given in the following table (Tab. 2) and in Figure (Fig.1).

Table 2 - The Labour-protection stickers located on the machine

WARNING SAFETY LABELS	TEXT TO THE LABELS	POSITION ON THE MACHINE
	<p>Before handling the machine, carefully read the operating manual. Observe the instructions and safety regulations for machine operation during use.</p>	P 1 H
	<p>Driving the machine and transportation on its construction is strictly forbidden.</p>	P 37 H
	<p>When connecting or disconnecting, do not step between the tractor and the machine, also do not enter this space, if the tractor and the machine are not at rest and the engine is not turned off.</p>	P 2 H
	<p>Stay outside the reach of the unsecured side frames of the machine.</p>	P 50 H
	<p>Stay outside the reach of the tractor - agricultural machine set, if the tractor engine is in operation.</p>	P 6 H

	<p>When unfolding the side frames into the transport position, do not reach into the area of contact with the central frame.</p>	<p>P 20 H</p>
	<p>Secure the side frames against unfolding and the axle against sudden fall prior to the transportation of the machine.</p>	<p>P 13 H</p>
	<p>When working and transporting the machine, maintain safe distance from the electric appliances.</p>	<p>P 39 H</p>
	<p>Secure the machine from undesirable movement by activating the hand brake.</p>	<p>P 52 H</p>
	<p>Do not approach the rotary parts of the machine unless they are standing still, i.e. they are not rotating.</p>	<p>P 53 H</p>
	<p>It is strictly folding and unfolding the side frames on slopes or inclined surfaces.</p>	<p>P 100 H</p>
	<p>Lubrication of house bearings.</p>	

Fig.1 – The Labour-protection stickers located on the K 1250 PS, K 1570 PS

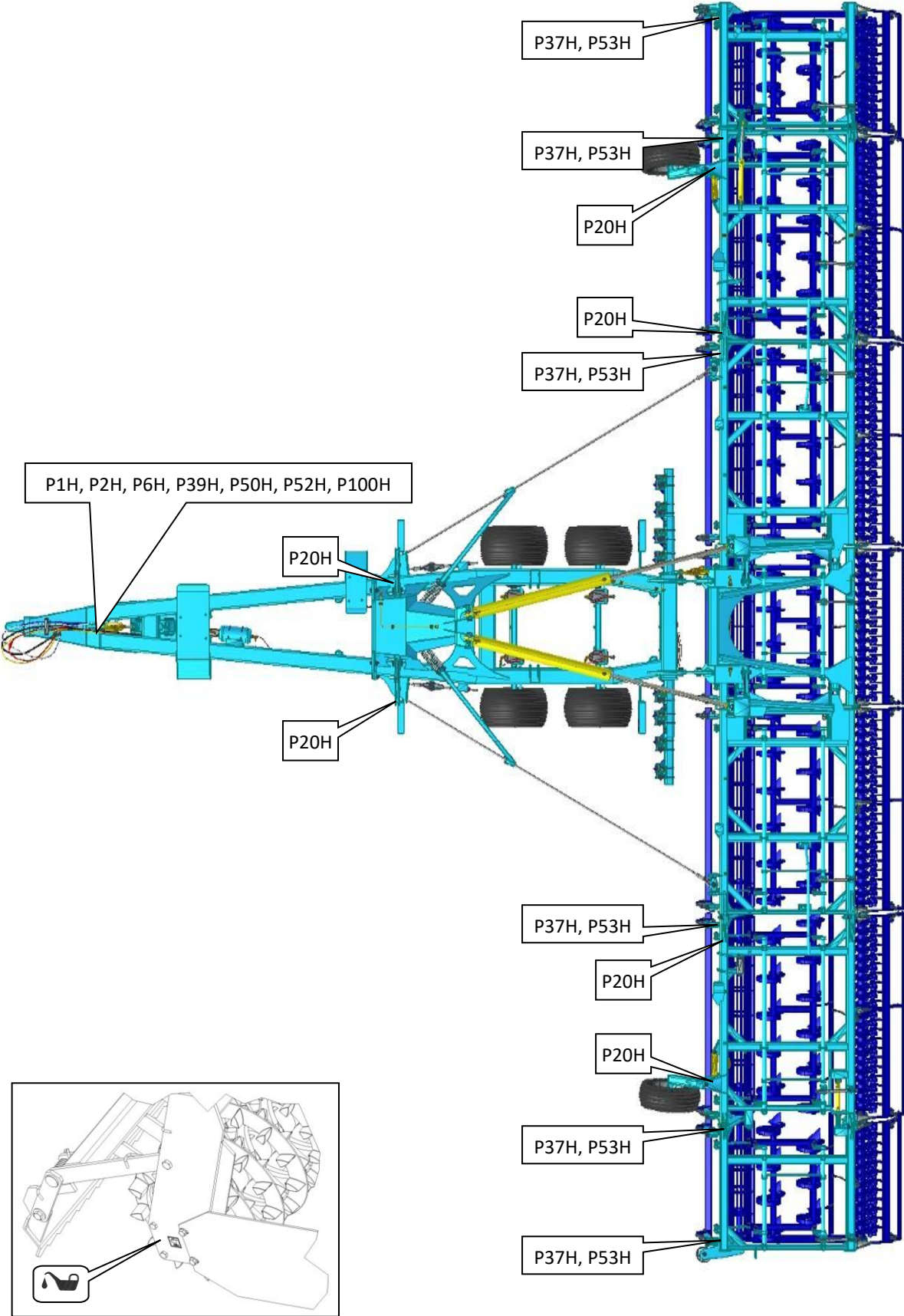

1. MACHINE DESCRIPTION

The machine has been designed as semi-mounted and folding. The basic version of the machine includes a chassis and drawn working sections. The machine is structurally designed so that the transport width is up to 3 m and the transport height is up to 3.5 m.

The chassis with the drawn appliance aggregates with a height-adjustable hole for a tractive bolt with \varnothing 50 mm. The chassis includes a supporting leg that supports the machine when it is disconnected from the tractor and there are two firm delayed axles, out of which one is equipped with an automatic parking brake function. Furthermore, the chassis includes hydraulically controlled catches securing the side frames in the transport position. The chassis also includes automatically spring-loaded trail cultivators.

The working section is attached to the chassis by swinging segments that allow continuous height tracing of the field behind the tractor and chassis. Furthermore, the working section is connected to the chassis by main piston rods and tractive ropes that transfer the tractive force from the tractor to the machine during the work in the field. The working section of the machine consists of a massive spring-loaded, height-adjustable variable leveller, crumbling front rollers, height-adjustable ploughshare section with a leveller and compactors with a rear leveller. Furthermore, the working section includes auxiliary wheels that are used for unfolding the machine into the working position or folding it into the transport position.

Fig. 2 - Machine Description K 1250 PS - K 1570 PS

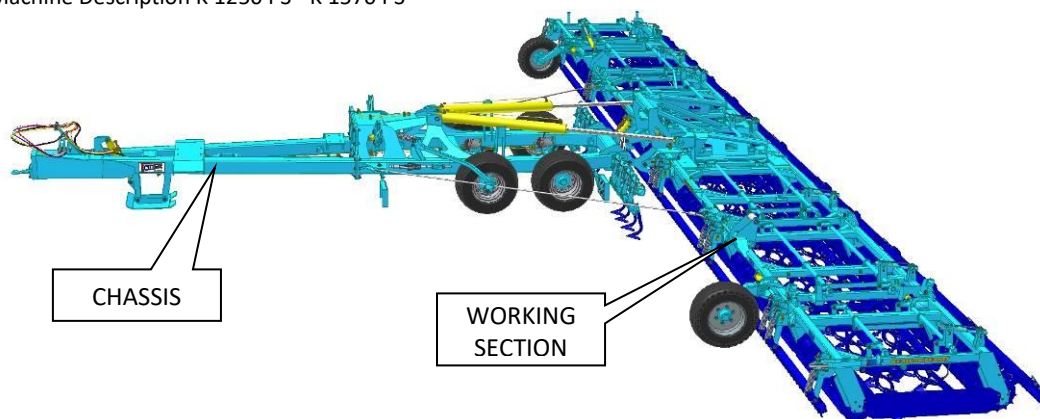

1.1 Aggregation to a tractor

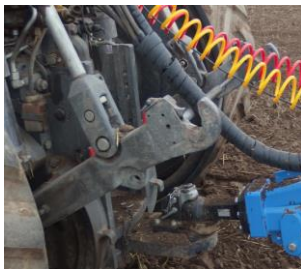

HITCH VERSION – K80; C40; C50; C70

Aggregation of the machine to the fixed bottom hitch with a K80 ball or with a pulling loop with the diameter of 40mm, 50mm or 70mm.

1.2 Working parts

TRACK CULTIVATOR



CA – Track Cultivator with Sweep

Automatically released tractor track cultivator with a sweep. Suitable for loose types of soil where there is no risk of formation of wet clods. Possibility of mechanical depth setting up to 80mm. Possibility of setting the position directly behind the tractor wheels.



CC – Track Cultivator with Chisel Share

Automatically released tractor track cultivator with a chisel share. Suitable for heavier types of soil where there is no risk of formation of wet clods. Possibility of mechanical depth setting up to 80mm. Possibility of setting the position directly behind the tractor.

FRONT LEVELLERS

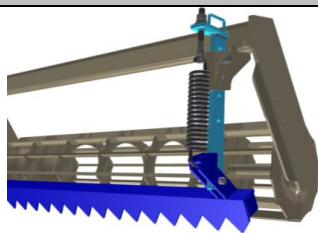

FL - FH – Front Fixed Serrated Levelling Bar

- Automatically released levelling bar with a serrated section. Massive construction for precise levelling of coarse furrows.
- Possibility to adjust the height of the leveller; the leveller spring preloading may be changed.
- You can choose either manual adjustment of the leveller height or hydraulically controlled leveller height.

FRONT WORKING ROLLERS



SB – Spiral Bar Roller - Ø40 cm - 60 kg/m – 9 bars

- Quality clod crumbling.
- Suitable for humid conditions.
- This type of roller can be used as the FRONT or REAR roller.

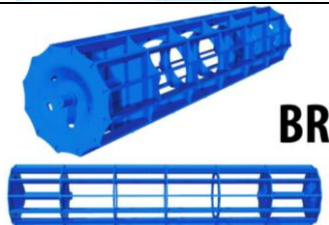

BR - Bar Roller - Ø40 cm - 60 kg/m – 12 bars

- Very good quality clod crumbling.
- Not suitable for humid conditions.
- This type of roller can be used as the FRONT or REAR roller.

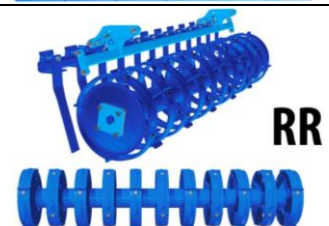

RR – Ring Roller Ø40 cm - 115 kg/m

- Quality work in all types of soil.
- Good depth guiding.
- Suitable for more humid soils.
- This type of roller can be used as the FRONT or REAR roller.

	BR	SB	RR
Crumbling	●●●○	●●●○	●●○○
Compacting	●●●○	●●●○	●●●●
Depth guiding	●●●●	●●●●	●●●●
Resistance to clogging	●●○○	●●○○	●●●●
Suitable for rocky soils	●●●○	●●●○	●●●○
Suitable for wet soils	○○○○	●●○○	●●●●
Heavy soils	●●○○	●●○○	●●●○
Medium soils	●●●○	●●●○	●●●○
Light soils	●●●●	●●●●	●●●○
● – MAX / ○ - MIN			

SHARE SECTIONS

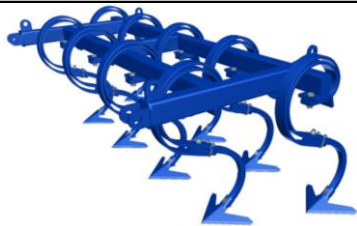

AL – Section of shares with sweeps in two rows

The share section is equipped with sweeps with the width of 25 cm in two rows. Each sweep is protected by a leaf spring. This section is suitable for lighter soil conditions without plant residues. There is a leveller behind the sweeps.



CF – Section of chisel shares in four rows

The share section is equipped with slim chisels with the width of 7 cm in four rows. The section is suitable for processing soil in spring when it is not suitable to pull wet soil out to the surface, or for heavy soils. There is **no** leveller behind the chisels.



AP – Section of shares with sweeps in two rows

A universal share section is equipped with sweeps with the width of 25 cm in two rows. The sweeps are mounted to frames with geometry improving the permeability of plant residues. Therefore, this section is suitable for land with a higher occurrence of crushed plant residues as well as for heavy soils. There is a leveller behind the sweeps.

	AL	CF	AP
Number of rows of shares (pieces) / Row spacing (mm)	2 / 400	4 / 240	2 / 490
Leveller behind shares	●●●●	○○○○	●●●●
All-area processing	●●●●	●●●○	●●●●
Suitable for light soils	●●●●	●●●●	●●●●
Suitable for medium soils	●●●○	●●●○	●●●●
Suitable for heavy soils	●●●○	●●●○	●●●●
Suitable for rocky soils	●●●○	●●●○	●●●●
Suitable for wet soils	●●○○	●●●●	●●○○
Resistance to clogging	●●○○	●●●○	●●●○

● – MAX / ○ – MIN

LEVELLING BARS BEHIND SHARES

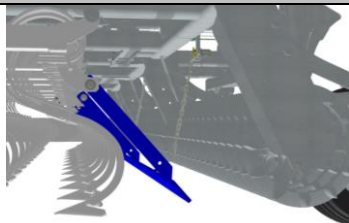

LEVELLING BAR BEHIND SHARES

The bar can be used behind all types of share sections. The bar is used for spreading the loosened soil before the rear roller. The height adjustment is performed using a chain, which the bar is suspended from.

REAR WORKING ROLLERS

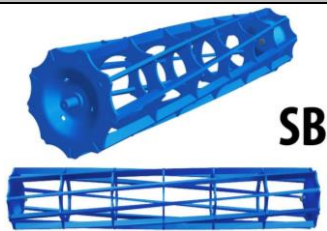

SB – Spiral Bar Roller - Ø40 cm - 60 kg/m – 9 bars

- Quality clod crumbling.
- Suitable for humid conditions.
- This type of roller can be used as the FRONT or REAR roller.

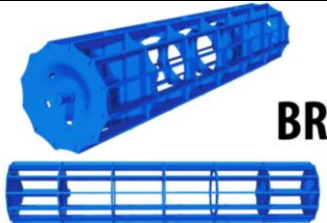

BR - Bar Roller - Ø40 cm - 60 kg/m – 12 bars

- Very good quality clod crumbling.
- Not suitable for humid conditions.
- This type of roller can be used as the FRONT or REAR roller.

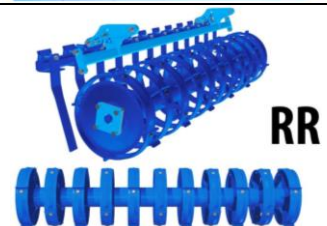

RR – Ring Roller Ø40 cm - 115 kg/m

- Quality work in all types of soil.
- Good depth guiding.
- Suitable for more humid soils.
- This type of roller can be used as the FRONT or REAR roller.



CR – Cross-kill Roller with Cleaner - Ø40 cm - 170 kg/m

- Quality clod crumbling and backwards compaction.
- Excellent work in light, medium and heavy soils.
- Not suitable for more humid soils.
- Not suitable for soils with a large quantity of rocks.
- This type of roller can be used as the REAR roller only.

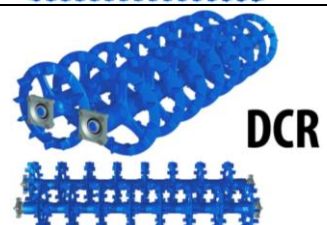

DCR – Double-row Cross-kill Roller - Ø40 cm / Ø40 cm - 175 kg/m

- Quality clod crumbling and backwards compaction.
- Mixes the processed soil more intensely.
- Excellent work in light, medium and heavy soils.
- Can work in slightly moist conditions.
- Not suitable for rocky soils.
- This type of roller can be used as the REAR roller only.

	BR	SB	CR	DCR	RR
Crumbling	●●●○	●●●○	●●●●	●●●○	●●○○
Compacting	●●●○	●●●○	●●●●	●●●○	●●●●
Depth guiding	●●●●	●●●●	●○○○	●●○○	●●●●
Resistance to clogging	●●○○	●●○○	●●○○	●●●●	●●●●
Suitable for rocky soils	●●●○	●●●○	●●○○	●○○○	●●○○
Suitable for wet soils	●○○○	●●○○	●●○○	●●●○	●●●●
Heavy soils	●●○○	●●○○	●●○○	●●●○	●●○○
Medium soils	●●●○	●●●○	●●●●	●●●●	●●○○
Light soils	●●●●	●●●●	●●●●	●●●●	●●○○
● – MAX / ○ - MIN					

FINISHING OPERATIONS

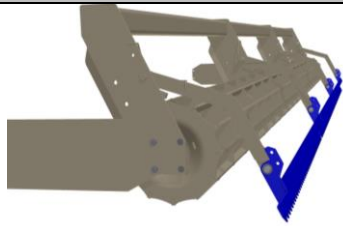

LF - REAR FINISHING LEVELLING BAR

The levelling bar behind the rear roller levels and evenly spreads the loosened soil. Possibility to change the angle of the leveller using backstop plates ➔ thus increasing the efficiency of the leveller.

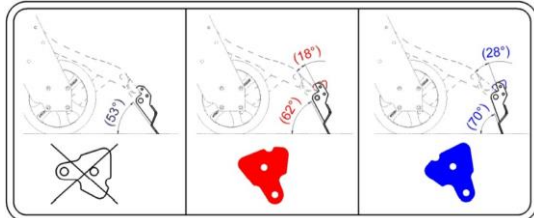

SUPPORT END STOPS OF THE FINISH LEVELLER

The end stops are used for the optional change in the finish leveller angle. When needed, it may improve the work of the leveller and the quality of the cultivated soil.

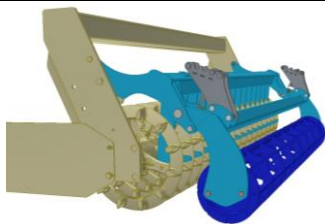

RF - REAR FINISHING ROLLER Ø220mm

The finishing roller actively disintegrates any remaining clods behind the rear roller. Possibility to change the preloading of the draw spring tension ➔ thus increasing the efficiency of the finishing roller.

!!Be careful – the finishing roller cannot be used behind the two-row cross-kill rollers.

2. SPECIFICATIONS

Table 3 - Specifications

PARAMETERS	K 1250 PS	K 1570 PS
Operating width (mm)	12500	15700
Transport width (mm)		3000
Transport height (mm)		3500
Transport length of the machine (mm)		9550
Working length of the machine (mm)		11550
Working depth (mm)		0-100
Number of shares	53	67
Working performance (ha/hour)	10-15	12,4-18,5
Working speed (km/hour)		8-12
Towing means (kW)	243	316
Maximum transport speed (km/hour)		25
Maximum slope accessibility (°)		6
Tyre dimensions (type)		19.0/45-17 14PR
Tyre pressure (kPa)		400
Weight of the machine (ver.II)	10500	12500

3. OPERATIONAL SAFETY RULES

- Before you take over the machine, please check that it has not been damaged during transportation and that all its parts have been supplied according to the delivery note.
- Before setting the machine to work, please read these Operating manual carefully.
- Before starting to work, please acquaint yourself with the overall functioning of the machine and its controls.
- Please observe not only the rules of these Manual but also general labour-protection, fire-protection and environment-protection regulations as well as transportation safety rules.
- The machine may only be operated by a person, which meets requirements of the item **A.3** above.
- Before setting the machine to work, please check its condition. In case of showing any signs of damaging, the machine must not be operated.
- When aggregating the machine with the tractor, follow the Instruction given in Chapter **E**/Page 5 to 6.
- Execute aggregation of the machine with the tractor on an even and compact surface.
- Before uncoupling the tractor and the machine in the transport position, the machine must be secured against accidental and undesirable unfolding, i.e. the folded lateral frames must be locked by the connecting bar.
- When working on slopes, observe the slope accessibility of the whole **TRACTOR-MACHINE** set.
- It is strictly forbidden to unfold or fold the machine on slopes – see the **P100H** labour-protection (safety) sticker located on the machine.
- Before starting up the tractor, check that there is no unauthorized person within the operating reach of the set and sound the horn.
- Operators should pay attention to any person's not approaching the machine during operation in the field.
- It is forbidden to dismantle the parts of the machine hydraulic system that are under pressure.
- Hydraulic oil penetrating the skin under high pressure causes serious injuries. Should this happens, call the doctor immediately.

4. ROAD TRANSPORT RULES

- The transport speed of the tractor with the machine should not exceed **25 km p.h.**
- When transporting the machine on public roads, follow the instruction given in Chapter **G**/Page 6.
- When transporting the machine on roads, the operator(s) should observe the applicable law and regulations including those which specify the tractor axle load depending on the transport speed.
- When transporting the machine on ground communications, the side frames must be secured by the connecting rod and the machine must be fitted with safety shields with a functional light set.
- Considering the size of the machine, the operator transporting the machine must be very careful and considerate to other road users.

Checking the nuts on the transport axle

- Use the plastic arrow “Check Point” to check for loose nuts. It promptly shows the condition of the nuts, whether they are loose or not.
- Always check the Check Points before driving.
- When the arrows are not facing one another, the nuts have to be tightened to the required torque and the Check Point arrows have to point against one another as shown in the green picture.

Torque for the axle nuts:
M18x1,5 - 265Nm
M20x1,5 - 343Nm
M22x1,5 - 440Nm

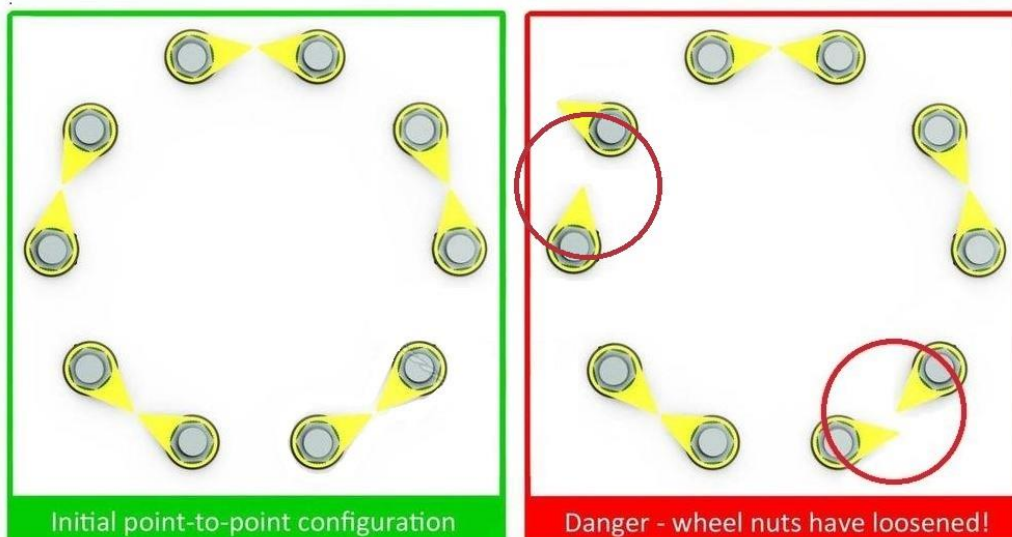

5. SETTING TO WORK

- When aggregating the machine with the tractor and setting it to work, the steps given in Chapter E, F /Page 5 to 6 should be followed.
- Aggregate the machine with a tractor with the use of the bottom hitch with a \varnothing 50 mm or \varnothing 70 mm bolt or with K80 tow ball.
- Place the trail cultivators on the chassis so that they cultivate the compacted layer of soil made by the tyres of the chassis and the tractor. The range of the position of cultivators may be selected even for tractors with a pair assembly, i.e. up to the width of 3.9 m. The maximal recess of cultivators is 60 mm below the level of the tractor wheel trail.
- To interconnect the hydraulic systems, use the quick-couplers of the identical model (the socket on the machine and the plug on the tractor) - the machine is normally provided with the ISO 12.5 quick couplers.
- Always fold and unfold the machines on a flat surface. Or meet the requirement of the P100H safety label (see p. 10).
- Attach the hoses of the individual hydraulic circuits to the tractor in the order in which the hoses are labelled. The hydraulic circuits are designated with coloured rings (see Fig. 4).

Hydraulic of the machine



Parts of the hydraulic system of the machine, which are under pressure, are forbidden to disassemble. Hydraulic oil that penetrates the skin under high pressure causes severe injuries. In case of injury, seek a physician immediately.

- Connect the hydraulics only when the hydraulic circuits of the machine and the tractor (aggregate) are in a pressure-less condition.
- The hydraulic system is under high pressure. Regularly check for leaks and immediately remove obvious damage of all lines, hoses, and pipe unions.
- When seeking and removing leaks, use only the suitable tools.
- For connecting the hydraulic system of the machine to the tractor, use the plug (on the machine) and the socket (on the tractor) of the quick-couplers of the same type.
- For simplification, the hydraulic circuits are marked by different colours.

Fig.4-designation of the hydraulic circuits

OZNAČENÍ HYDRAULICKÝCH OKRUHŮ
DESIGNATION OF HYDRAULIC CIRCUITS
BEZEICHNUNG VON HYDRAULIKANLAGEN
НАЗНАЧЕНИЕ ГИДРАВЛИЧЕСКИХ КОНТУРОВ
DÉSIGNATION DES LIGNES HYDRAULIQUES

K1250PS=A+B+C+E / K1570PS=A+B+C+D+E

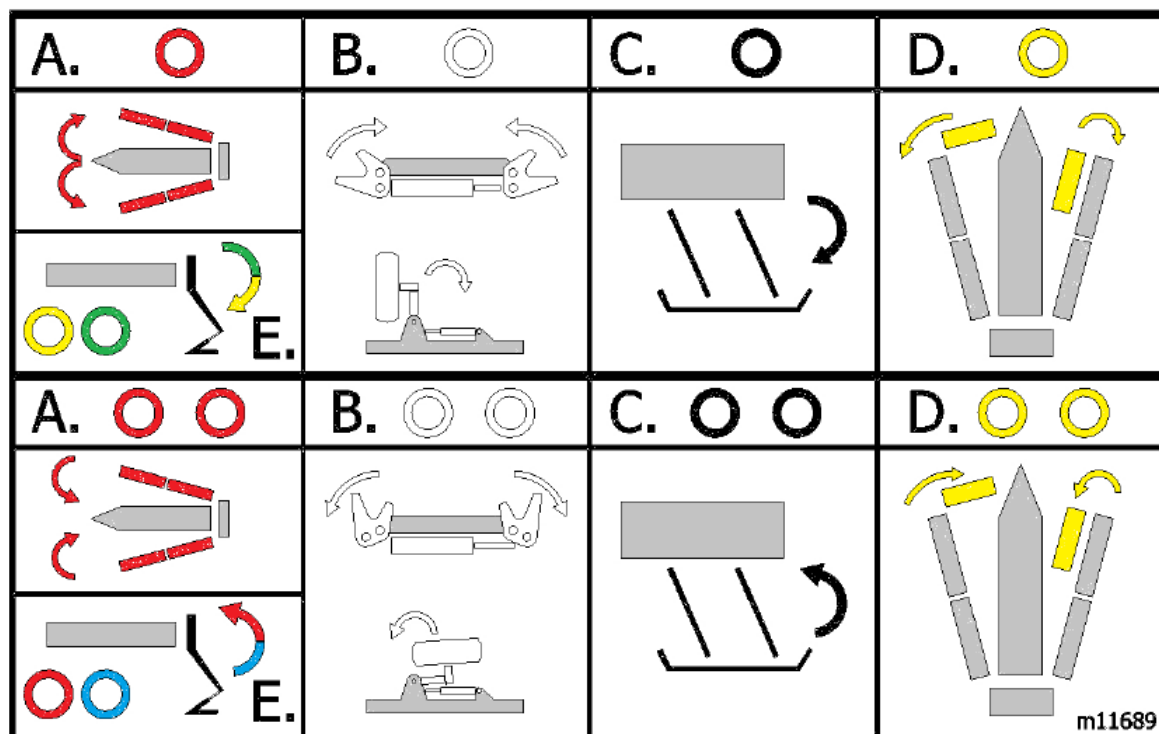

CIRCUIT A – the circuit for folding and unfolding side frames. Hydraulic circuit designated with **RED** rings. **This hydraulic circuit must always be turned on when working in the field.**

- DRAWING-OUT PISTON = UNFOLDING INTO THE WORKING POSITION**
The side frames are unfolded into the working position when this circuit branch is pressurised.
- PISTON RETRACTION = FOLDING INTO THE TRANSPORT POSITION**
The side frames are folded into the transport position when this circuit branch is pressurised

CIRCUIT B – the circuit for the control of transportation bolts together with auxiliary wheels. Hydraulic circuit designated with **WHITE** rings. **This hydraulic circuit does not need to be turned on when working in the field.**

DRAWING-OUT PISTON = FOLDING INTO THE TRANSPORT POSITION

By pressurising this circuit branch, the bolts lift the side frames into the transport position and the auxiliary wheels are folded to the frames into the transport position when the side frames have been lifted.

PISTON RETRACTION = UNFOLDING INTO THE WORKING POSITION

By pressurising this circuit branch, the auxiliary wheels are unfolded from the frames. Once unfolded, the bolts start to open and lower the side frames.

CIRCUIT C – the circuit for the control of the supporting leg of the chassis. Hydraulic circuit designated by **BLACK** rings. **This hydraulic circuit does not need to be turned on when working in the field.**

DRAWING-OUT PISTON = SETTING THE TRANSPORT POSITION

The supporting leg stands on the ground when this circuit branch is pressurised.

PISTON RETRACTION = SETTING THE WORKING POSITION

The supporting leg is lifted from the ground when this circuit branch is pressurised.

CIRCUIT E – the circuit for controlling the position of the track cultivators behind the chassis wheels. Hydraulic circuit designated by **MULTI-COLOUR** rings. **This hydraulic circuit must always be turned on when working in the field.**



Attention! Do not manipulate with this circuit when the machine is standing on hard surface (asphalt, concrete) as it could damage the track cultivators or the surface.

DRAWING-OUT PISTON = SETTING THE WORKING POSITION

Hydraulic circuit designated by a **YELLOW + GREEN** ring. The track cultivators are set into the working position when this circuit branch is pressurised.

PISTON RETRACTION = SETTING THE TRANSPORT POSITION

Hydraulic circuit designated by a **RED + BLUE** ring. The track cultivators are set into the transport position when this circuit branch is pressurised.

CIRCUIT D – the circuit for folding and unfolding the external 1.5m side frames. Hydraulic circuit designated by **YELLOW** rings. This hydraulic circuit is only installed in K1570PS.

This hydraulic circuit does not need to be turned on when working in the field.

UNFOLDING SIDE 1.5m FRAMES INTO THE WORKING POSITION

The external side frames are open into the working position when this circuit branch is pressurised.

FOLDING SIDE 1.5m FRAMES INTO THE TRANSPORT POSITION

The external side frames are open into the transport position when this circuit branch is pressurised.

	<p>HYDRAULIC CIRCUIT FOR FRONT LEVELLER POSITION CONTROL - ONE BLUE RING Pressurizing this branch of the circuit brings the leveller up from the surface.</p>	<p>Flow limiters reducing the speed of the piston-rod operation are used in the circuit. The precise position can be found in the Spare Parts Catalogue.</p>
	<p>HYDRAULIC CIRCUIT FOR FRONT LEVELLER POSITION CONTROL - TWO BLUE RINGS Pressurizing this branch of the circuit recesses the leveller to the surface.</p>	
	<p>HYDRAULIC CIRCUIT FOR SHARE WORKING DEPTH CONTROL - ONE GREEN RING Pressurizing this branch of the circuit brings shares out of the processed profile.</p>	
	<p>HYDRAULIC CIRCUIT FOR SHARE WORKING DEPTH CONTROL - TWO GREEN RINGS Pressurizing this branch of the circuit recesses shares into the processed profile.</p>	

Hydraulic diagram of the support leg

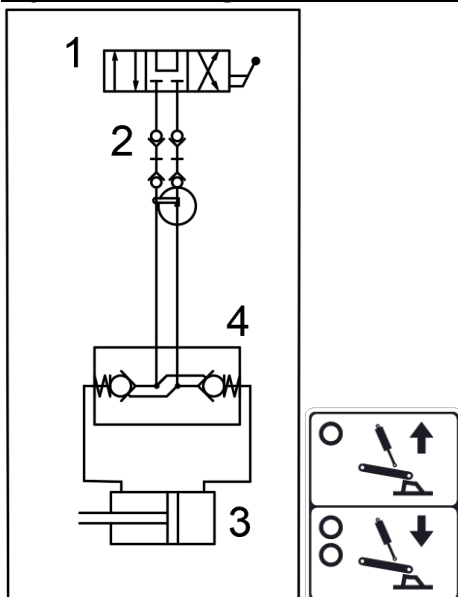

Hydraulic diagram K1250PS-FRONT LEVELLER POSITION CONTROL

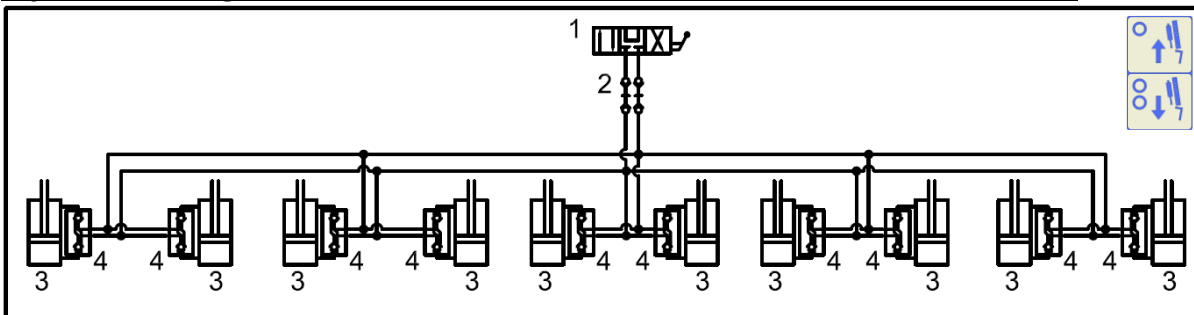

- 1-Control distributor in the tractor
- 2-Hydraulic snap couplings
- 3-Hydraulic cylinders of leveller control
- 4-Hydraulic closing valve for leveller cylinders

Hydraulic diagram K1250PS-SHARE WORKING DEPTH CONTROL

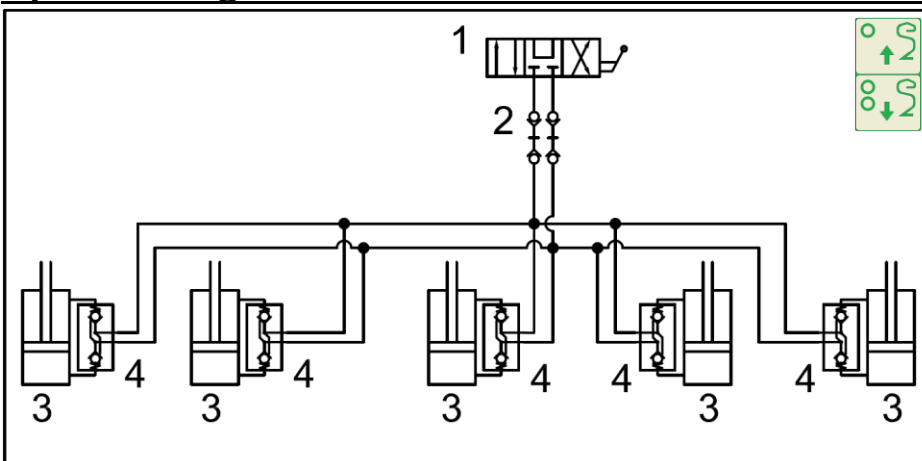

- 1-Control distributor in the tractor
- 2-Hydraulic snap couplings
- 3-Hydraulic cylinders of share depth control
- 4-Hydraulic closing valve for share depth cylinders

6. AGREGATION WITH THE TRACTOR

- For safe aggregation, observe the regulations given in Chapter E / Page 5 to 6.
- Only aggregate the machine with a tractor in the lower hitch with a \varnothing 50 mm or \varnothing 70 mm bolt or in K80 tow ball, even when the machine is just being transported (see Fig.5).
- The machine may only be aggregated with a tractor with an output intended for such use according to Chapter No. 2.
- As additional load to the tractor (counterweight) only the weights prescribed by the manufacturer should be used.
- Only aggregate the machine with a tractor equipped with single-circuit two-hose brake.

Fig. 5 – Connecting the machine with the lower tractor hitch



7. PROCEDURE FOR UNFOLDING INTO THE WORKING POSITION

	K1250PS	K1570PS
	1.	1.
	2.	2.

- 7.1** It is necessary to connect the machine with the lower hitch of the tractor with a \varnothing 50 mm bolt for safe unfolding and folding. When handling and unfolding the machine, the tractor hitch is loaded with vertical force of 25 kN up and 35 kN down!!! Thus the tractor hitch must meet this requirement!

Fig.6 –Illustration of the load of the lower tractor hitch during folding and unfolding



7.2 Prior to unfolding, dismantle the warning shields and attach them to the hangers on the pole. Fold and unfold the machine on a sufficiently large and even area. If you are standing on a slight slope, place the machine set so that it is oriented up the slope in the driving direction. When folding, the tractor and the machine must be locked and the movement of the set must be prevented!

Fig.7 - K 1570 PS prior to unfolding



Fig.8 – place for storing safety shields

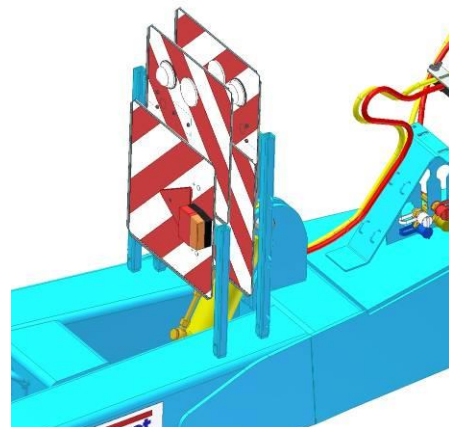

7.3 UNFOLDING THE MACHINE – PHASE 1 – WHEELS AND CATCHES



Start unfolding by **Circuit B = pressurise the circuit branch designated by two white rings**. Firstly, the side wheels will unfold and then the catches will open and the side frames will apply a load on the auxiliary wheels. **Warning: to make the wheels and catches open fully, the piston rods must reach their final positions!!** The flow of oil in the piston rods is purposely choked by jets and thus it is not necessary to set a large flow of oil in the tractor.

If the field is raised in the place of the supporting wheels and the wheels do not unfold fully, it is possible to raise the pole of the machine by the supporting leg with the use of hydraulic **circuit C = pressurise the circuit branch designated by one black ring**.

Fig.9 – Auxiliary wheels are in the transport position



Fig.10 – Auxiliary wheels are prepared for unfolding



7.4 UNFOLDING THE MACHINE – PHASE 2 – OPENING AND TIPPING

When the process of unfolding the wheels and the bolts has been completed, start with **Circuit A = pressurising the circuit branch designated by one red ring** for opening the side frames from the chassis. Firstly, the side frames will open to the sides and then the whole working section will unfold onto the ground. The flow in the main folding piston is purposely choked by a $\varnothing 2$ mm jet, so it is not necessary to set a large oil flow in the tractor.

7.5 UNFOLDING MACHINE K1570 – PHASE 2 - OPENING+TIPPING

When the process of unfolding the wheels and bolts has been completed, start with **Circuit A = pressurising the circuit branch designated by one red ring** for opening the side frames from the chassis. Firstly, the side frames will open to the sides (see Fig. 11). When the side frames controlled by Circuit A are open so that there is no risk of mechanical collision when opening the external 1.5-meter frames, start with **Circuit D = pressurising the circuit branch designated by one yellow ring** for unfolding the external 1.5-meter frames. If needed, the control of Hydraulic Circuit A may be interrupted until the external 1.5-meter frames have opened into the end position. Then, continue with **Circuit A = pressurising the circuit branch designated by one red ring** for finishing the tipping of the entire work section on the ground. The flow in the main piston of Circuit A is purposely choked by a $\varnothing 2$ mm jet, so it is not necessary to set a large oil flow in the tractor.

Fig.11 – The side frames are being unfolded

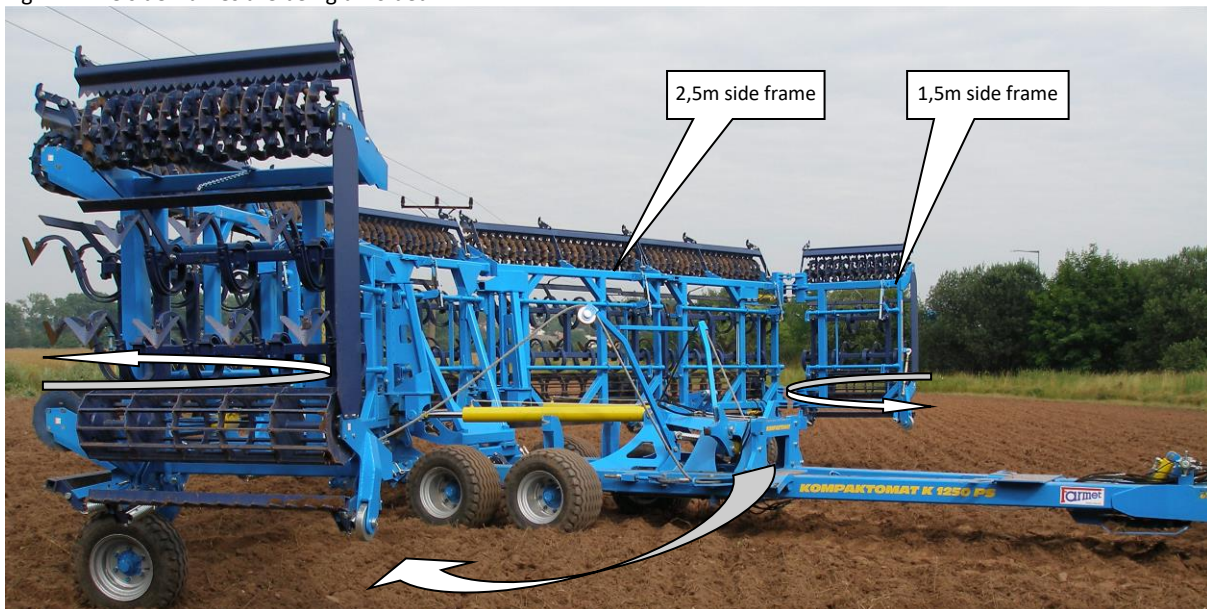

Fig.12 – Tipping the working section into the working position

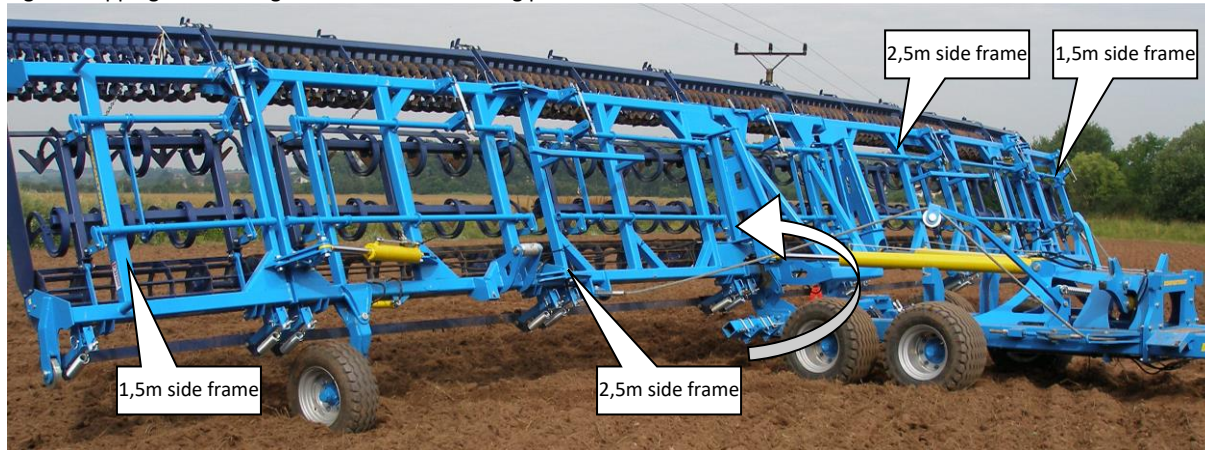

Fig.13 – Tipping the working section into the working position



When **UNFOLDING THE MACHINE PHASE 2** has been completed, i.e. the working section is unfolded and resting on the ground, **you must set Circuit A into floating position**. This will prevent the transfer of the chassis weight on the working section, or vice versa.

7.6 TRACK CULTIVATORS IN THE WORKING POSITION

Set the track cultivators in the working position after the machine has been unfolded into the working position. Start with **Circuit E = pressurising the circuit branch designated with one yellow and one green ring** for drawing out the piston to its end position.



Always perform this action on soft surface, not on concrete, asphalt or pavement as that could damage the cultivators or the surface.

8. PROCEDURE FOR FOLDING INTO THE TRANSPORT POSITION

	K1250PS	K1570PS
	1.	1.
	2.	2.
		m11690

8.1 TRACK CULTIVATORS IN THE TRANSPORT POSITION

Set the track cultivators for the transport position prior to folding the machine to the transport position. Start with **Circuit E = pressurising of the circuit branch designated by one red and one blue ring** for retracting the piston to the end position.

8.2 FOLDING MACHINE K1250 – PHASE 1 - TIPPING+CLOSING

Start with **Circuit A= pressurising the circuit branch designated by two red rings** for folding the working section of the machine so that the central frame is resting on the backstop on the chassis. Then continue until the side frames are folded to the chassis. The folded frames must be resting on the prepared bolts on the chassis. When both folded frames are resting on the bolts, turn off the hydraulic circuit.

The flow in the main unfolding piston rod is purposely choked by a $\varnothing 2$ mm jet, so it is not necessary to set a large oil flow in the tractor.

8.3 FOLDING MACHINE K1570 – PHASE 1 - TIPPING+CLOSING

Start with **Circuit A= pressurising the circuit branch designated by two red rings** for folding the working section of the machine so that the central frame is resting on the backstop on the chassis. At this moment, it is possible to start closing the external 1.5-meter frames: start with **Circuit D = pressurising the circuit branch designated by two yellow rings**. If needed, the control of Hydraulic Circuit A may be interrupted until the external 1.5-meter frames have closed in the end position. Then, continue until the side frames are closed in the direction to the chassis. The folded frames must be resting on the prepared bolts on the chassis. When both folded frames are resting on the bolts, turn off the hydraulic circuit.

The flow in the main pistons of folding (Circuit A) is purposely choked by $\varnothing 2$ mm jets, so it is not necessary to set a large oil flow in the tractor.

Fig.14 – The side frames are rising from the ground



Fig.15 – Closing the working sections into the transport position

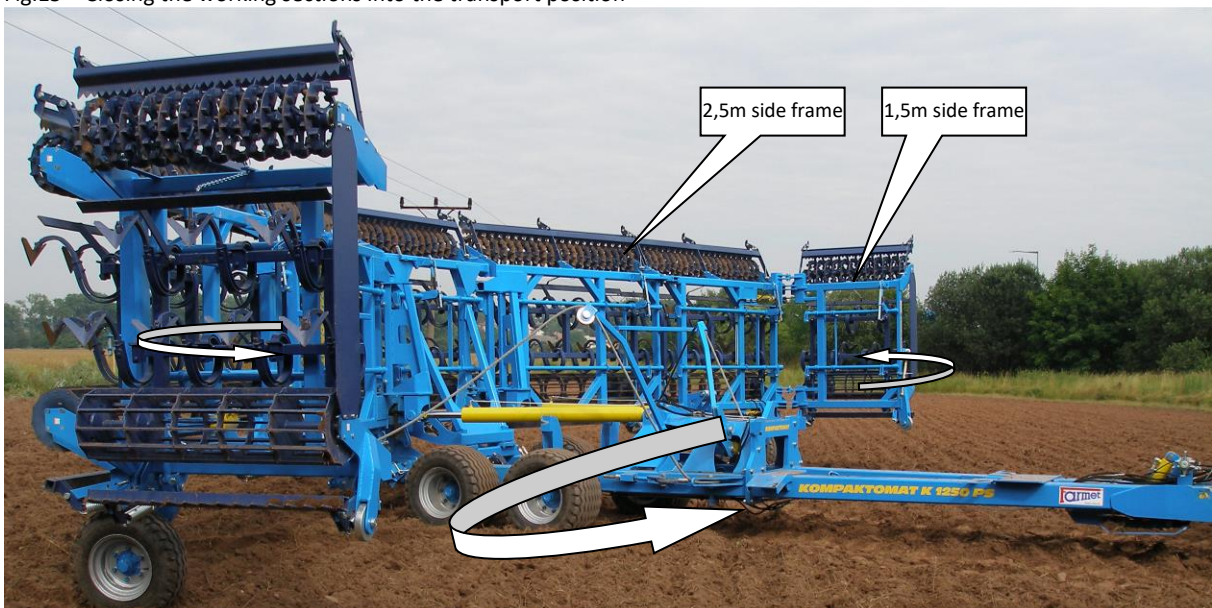

8.4 FOLDING THE MACHINE K1250+K1570 – PHASE 2 – CATCHES AND WHEELS

Start controlling the catches and auxiliary wheels, when the left and right side of the folding working sections reaches the catches. Then start folding by **Circuit B = pressurise the circuit branch designated with one white ring**. Firstly, the folded frames of the working sections will be raised with the help of the catches. Then, the auxiliary wheels will be released and automatically tipped into the transport position. Warning: to make the wheels and catches close fully, the piston rods must reach their final positions!! The flow of oil in the piston rods is purposely choked by jets and thus it is not necessary to set a large flow of oil in the tractor.

Fig.16 – The working section has reached the catches located on the chassis



When the machine folds into the transport position, secure the side frames by the connecting rod and place safety shields into the positions for transportation on ground communications.

Fig.17 – Placing the front safety shields



Fig.18 – Placing the rear safety shields



When **FOLDING THE MACHINE PHASE 2** has been completed, i.e. the working section is folded in the transport position, **you must set Circuit A into floating position**. This will prevent the transfer of the undesirable load of the side frames onto the pistons of Circuit A and potential damage incurred during transportation.

9. ADJUSTING THE WORKING PARTS OF THE MACHINE

- The position of the following individual working parts on the machine can be adjusted
 - Position and depth of the track cultivators
 - Height and down pressure of the front leveller
 - Depth of the shares
 - Position of the leveller behind the shares (only for sweeps)
 - Angle of the rear finishing levelling bar
- The control of the front leveller position and the share depth setting can be either mechanical, or automatic from the driver's position.
- The drawbars of folding can also be adjusted.

9.1 Adjusting the position and depth of the track cultivators

- The tractor track cultivator position can be adjusted either by height or length, as needed.
- When adjusting the track cultivator position, always observe generally valid labour safety regulations.
- Correct position of the track cultivator affects the resulting quality of processing.
- The track cultivators are located on the beams of the pulling fork. The drawbar beam for attaching track cultivators is telescopic.

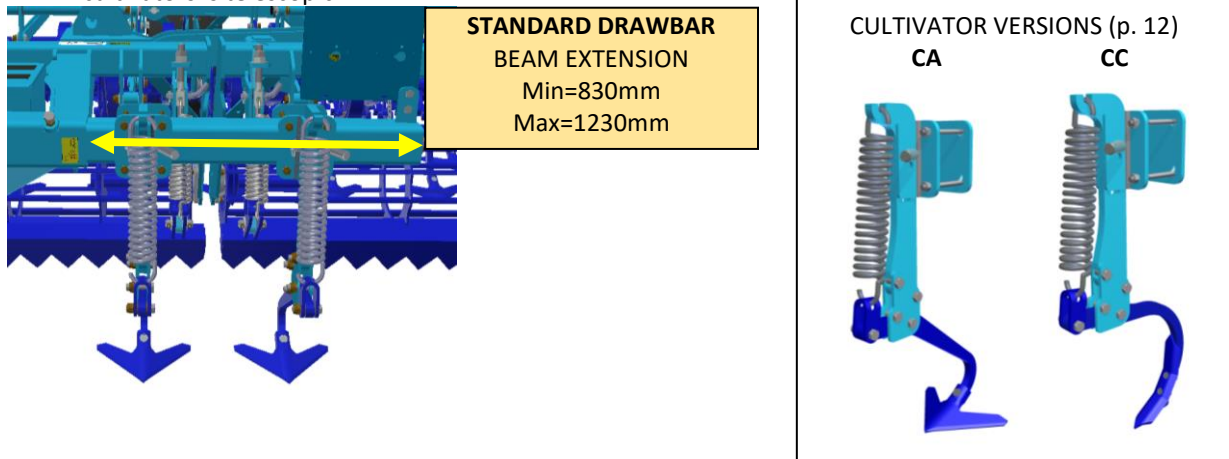

- The cultivator can be moved on the beam so that it loosens the compacted tractor wheel tracks. Lengthwise setting of the cultivators is performed by releasing the nuts of the screws and moving the cultivators along the beam into the position behind the tractor wheels so that they loosen the compacted tractor tracks.

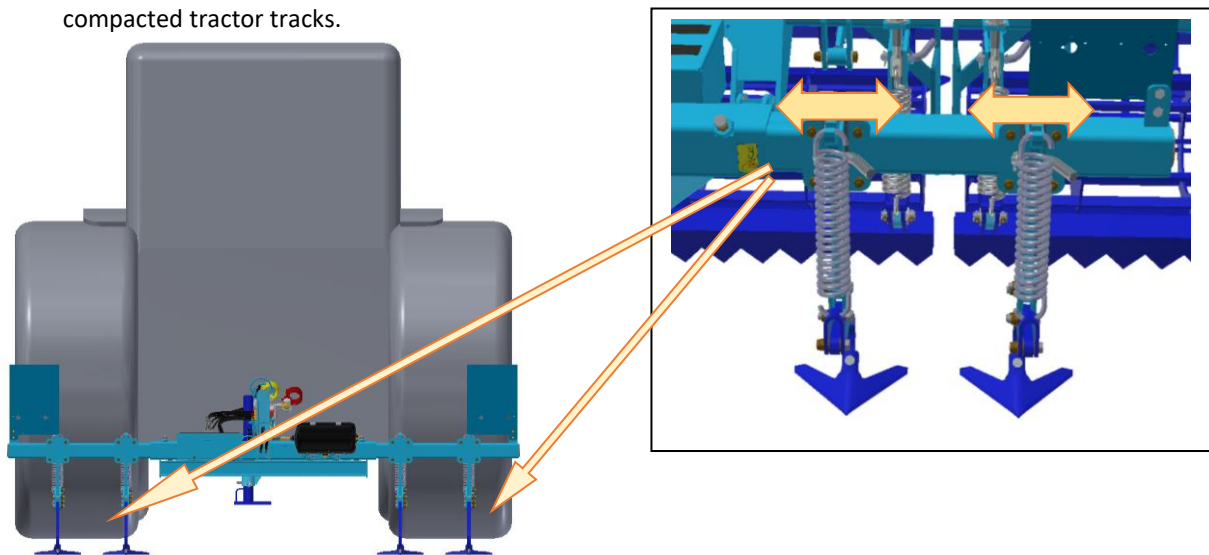

- Setting the depth of the cultivator is performed by removing the pin and moving the cultivator in the holder. Before setting the depth of the cultivators, set the machine in the position when the cultivators are not loaded.

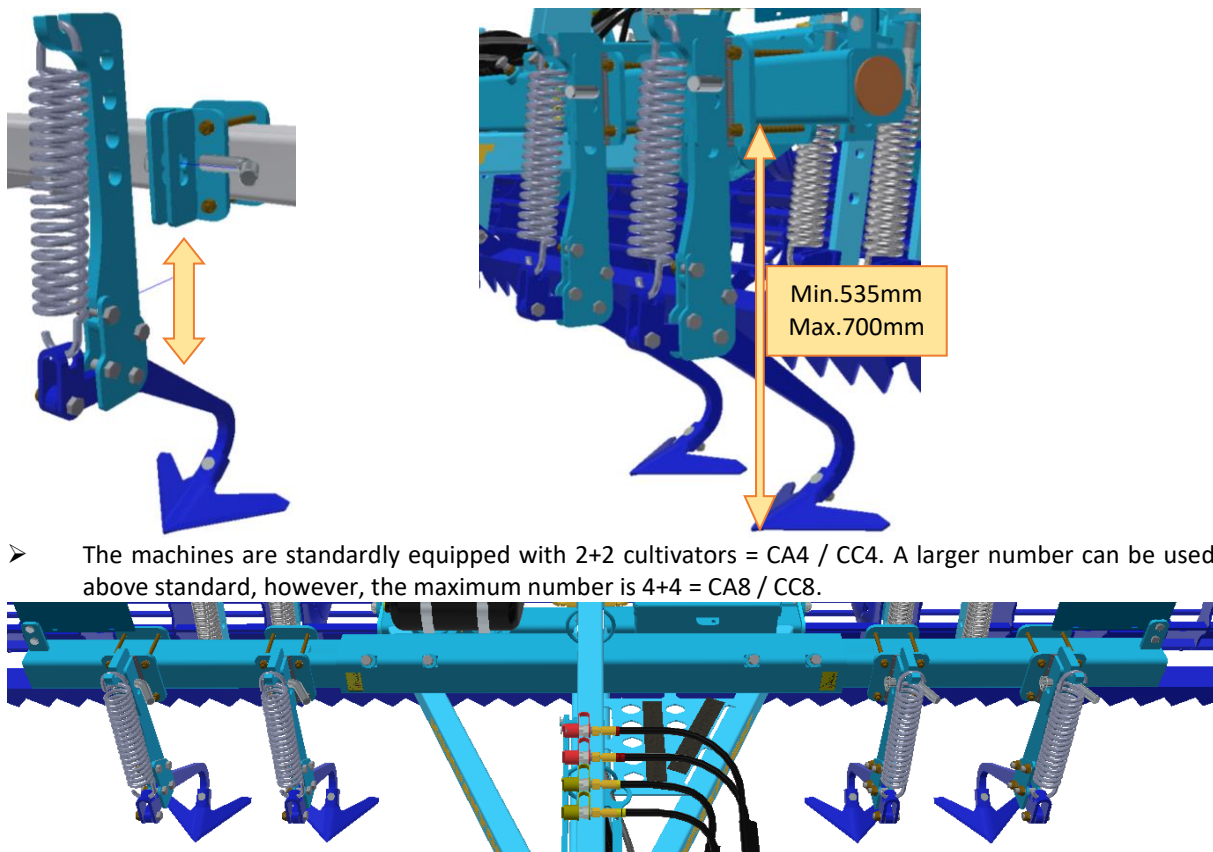

- The machines are standardly equipped with 2+2 cultivators = CA4 / CC4. A larger number can be used above standard, however, the maximum number is 4+4 = CA8 / CC8.

9.2 Adjusting the spring mounted front leveller

- Correct position of the front leveller affects the resulting quality of processing.
- When adjusting the position of the levellers, always observe generally valid labour safety regulations.
- Perform the adjustment of front levellers when the machine is unfolded in the working position and standing on the working sections at the same time.
- The front leveller is a very important part of the machine. It contributes largely to the levelling ability of the Kompaktomat machines. Therefore, it is important to adjust it properly.

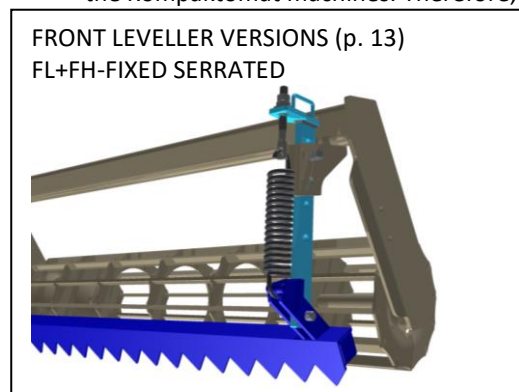

- As for the fixed serrated leveller, it is possible to adjust the height and the preloading of the draw spring.
- The basic version of the height adjustment is mechanical.
- It is possible to control the height of the leveller from the tractor cabin using a hydraulic circuit as an above-standard option.
 - The distribution of the hydraulic circuit includes elements providing even movement of all levelling bars. Therefore, do not limit the oil flow on the control panel of the circuit. The flow rate values should range between 75 and 100% capacity.
 - Without the manufacturer's prior consent, do not interfere with the hydraulic circuit components in any way!

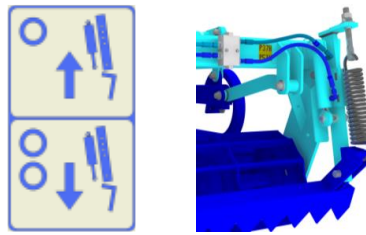

- The height of the front leveller is set in relation to the size of the clods and the field unevenness. The height of the leveller has to be adjusted according to the current conditions. When the leveller is too low, it will drag too much soil along, which reduces the tractor output. When the leveller is too high, it will not work, which will affect the final quality of work of the machine. We recommend to keep the leveller approx. 3cm above the surface when the machine is lowered down to the working rollers.

9.2.1 FL + FH – Front fixed serrated levelling bar

- The automatic release of the leveller is protected by a draw spring. The spring is factory-set to the length of 340mm; however, it is possible to change the preloading as needed. The spring preloading is selected according to the character of the field (size of clods in the field). The bigger the clods are, the higher the preloading needs to be.

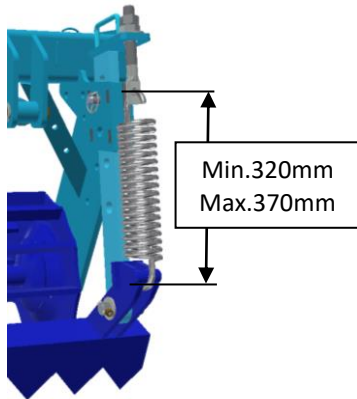

- Use an auxiliary control lever to make the manual leveller height setting easier.

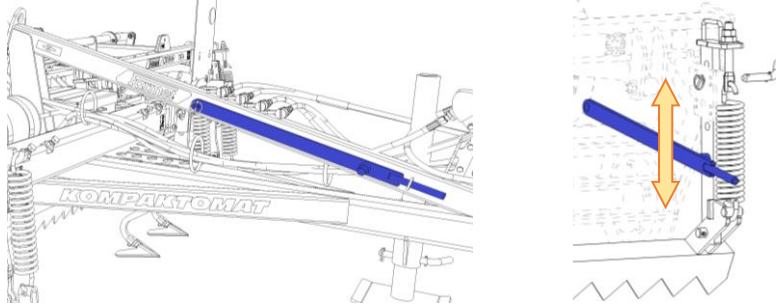

9.3 Adjusting the components of RING rollers

- The design of the special roller versions require adjustment in order to provide quality soil processing.
- Always adjust the rollers when the machine is in standstill and observe generally valid labour safety regulations.
- To keep the quality of soil processing, the position of the digital deflectors against the ring roller must be adjusted.
- Adjusting the position of deflectors can be highly individual. It depends on the soil and climatic conditions.

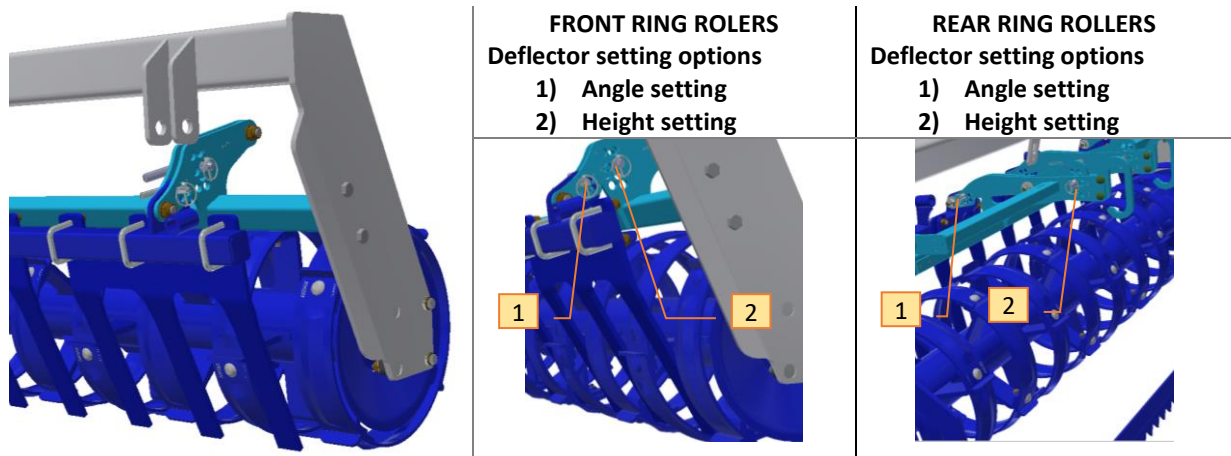

9.4 Adjusting the depth of the share section



- When adjusting the depth of the shares, always exercise extra caution as the working roller might turn.
- Always adjust the depth of the shares when the machine is in standstill and unfolded into the working position.
- The machine must be lifted on the axle and in the arms of the tractor so that it does not stand on the shares.
- The working depth of the shares is set in relation to the crop to be planted.
 - Beetroot...2-3 cm
 - Rapeseed ...3-5 cm
 - Wheat, barley, oats ...5-8 cm

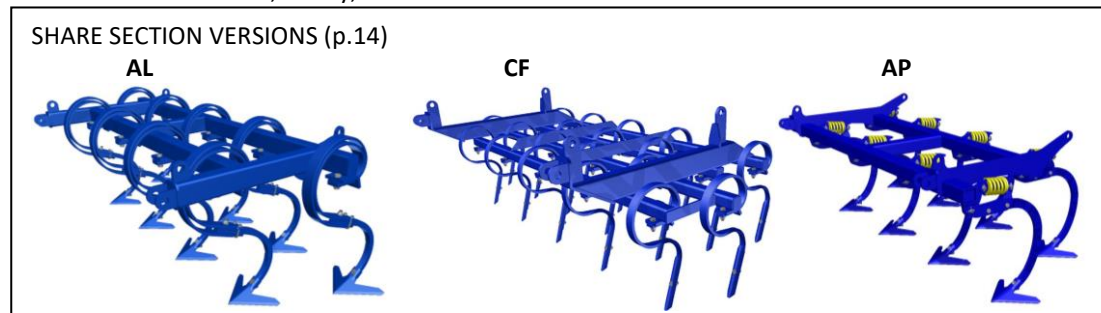

Machine	Number section (pc)
K1250PS	5
K1570PS	7

- The basic version of height setting is mechanical using a handle ...MCD

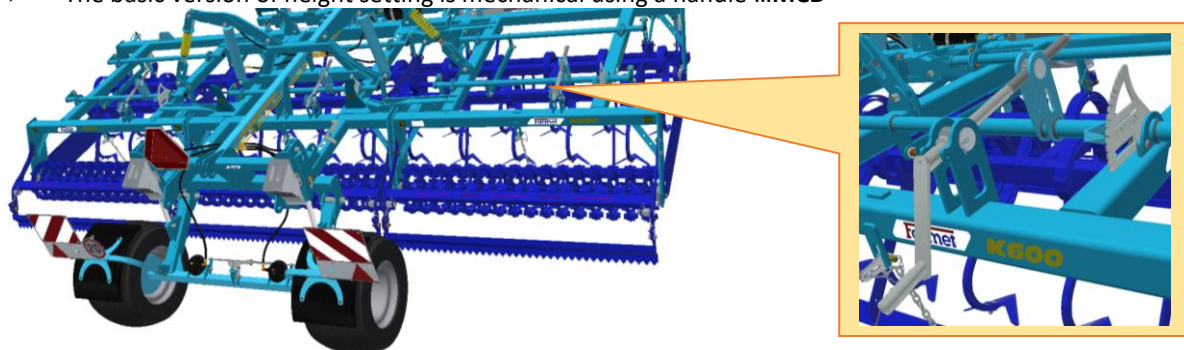

- The height of the shares can be controlled from the tractor cabin using a hydraulic circuit as an above-standard option ...HD
- The distribution of the hydraulic circuit includes elements providing even movement of all share frames. Therefore, do not limit the oil flow on the control panel of the circuit. The flow rate values should range between 75 and 100% capacity.

- Without the manufacturer's prior consent, do not interfere with the hydraulic circuit components in any way!

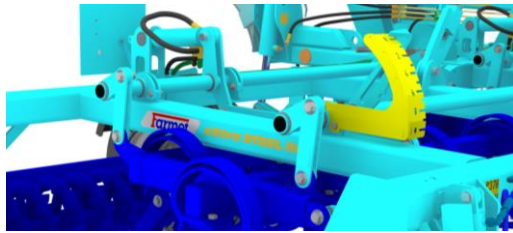

9.4.1 MCD-mechanical depth setting

- Standardly, the depth is set mechanically by turning the handle manually. Each working section of the machine is controlled individually.
- The depth setting is increased by turning the handle **anticlockwise** – **red arrows** in the picture.
- The depth setting is decreased by turning the handle **clockwise** – **white arrows** in the picture.
- There is an indicator near the handle that shows that all the sections are set at the same depth.

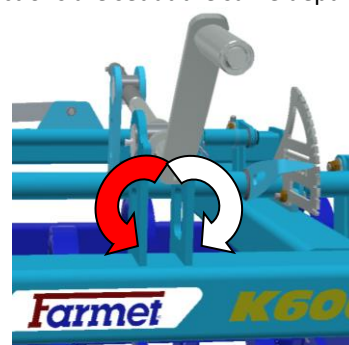
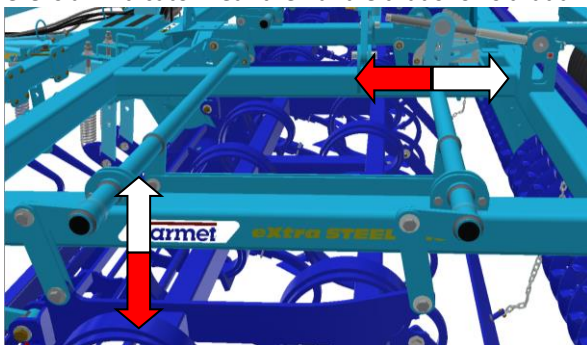

9.4.2 HD-hydraulic depth setting

- The depth is set from the tractor driver's position. All working sections are controlled at the same time.
- The depth setting increases when the piston-rods are drawn out – **red arrows** in the picture.
- The depth setting decreases when the piston-rods are drawn in – **white arrows** in the picture.
- There are indicators located in spots visible from the tractor that show that all the sections are set at the same depth.

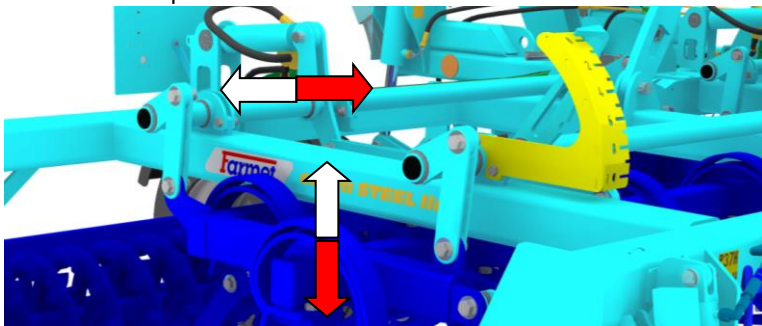

9.5 Adjusting the leveller height behind shares

- Perform the adjustment of the levellers when the machine is unfolded in the working position and standing still.
- The machine must rest on the working sections.
- When adjusting the position of the levellers, always observe generally valid labour safety regulations.
 - The leveller behind the shares is used for even spreading of the loosened soil behind the last row of sweeps in front of the rear roller.
 - Set the height of the leveller "V" according to the current soil conditions.
 - Correct position of the leveller affects the resulting quality of processing.
 - The correctly set leveller ensures that no tracks after the last row of shares are visible.
 - The position of the leveller is secured by inserting a chain loop into the hole on the supporting frame. The chain is secured by inserting a companion part and a safety pin.

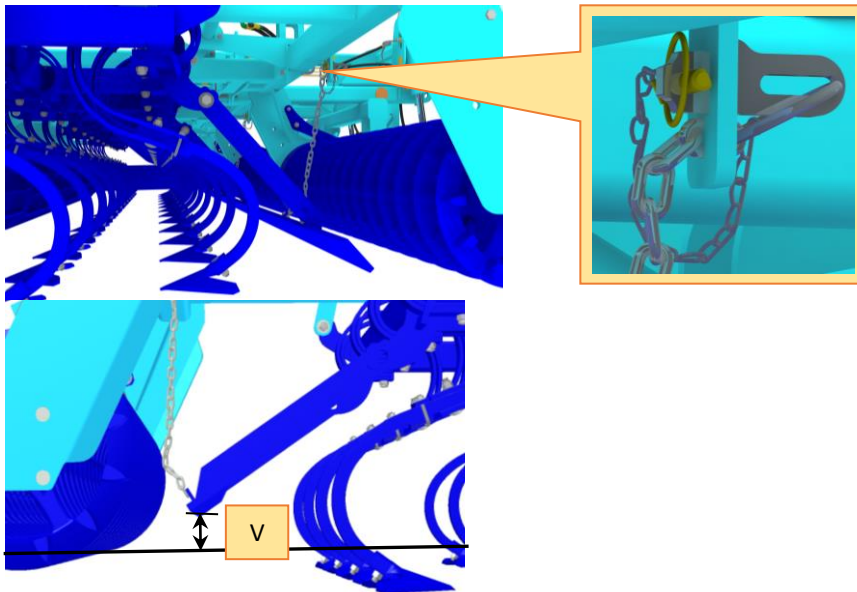

9.6 Setting the finishing section features

9.6.1 Setting the angle of the rear leveller

- When installing the leveller stops, always observe generally valid labour safety regulations.
- Correct function of the leveller affects the resulting quality of processing.

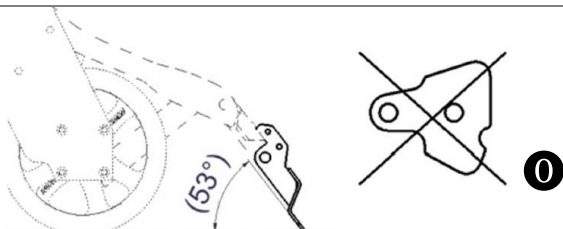

The angle of the finishing bar does not have to be changed in lighter soils or in deep cultivation when Kompaktomat creates enough loosened soil. **It means that the backstops do not need to be used 0.**

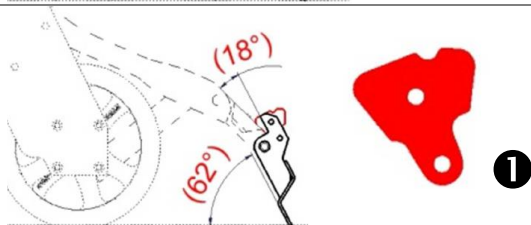

In heavier soils or shallow cultivation when Kompaktomat does not create enough loosened soil, it is possible to install backstops onto the rear leveller that increase the aggressiveness of its angle, thus assuring that the rear leveller generates a larger quantity of soil, improving the work of Kompaktomat.

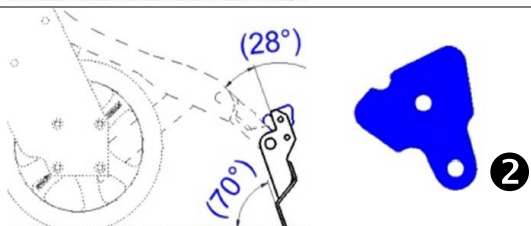

The backstop of the leveller is rotary but not symmetrical, thanks to which it is possible to create two angles of the leveller by turning the backstop.

① Smaller preloading... red rotation of the backstop.

② Greater preloading... blue rotation of the backstop.

There is a differentiating groove on the backstop for easier recognition during installation.

9.6.2 Setting the pressure of the finishing roller

- When adjusting the pressure, always observe work safety rules.
- The pressure mechanism of the finishing roller allows you to adjust the traction of the traction spring in three positions.
- To change the traction, use the level provided which you fix to the spring seating segment and shift along the rack with a swaying movement.

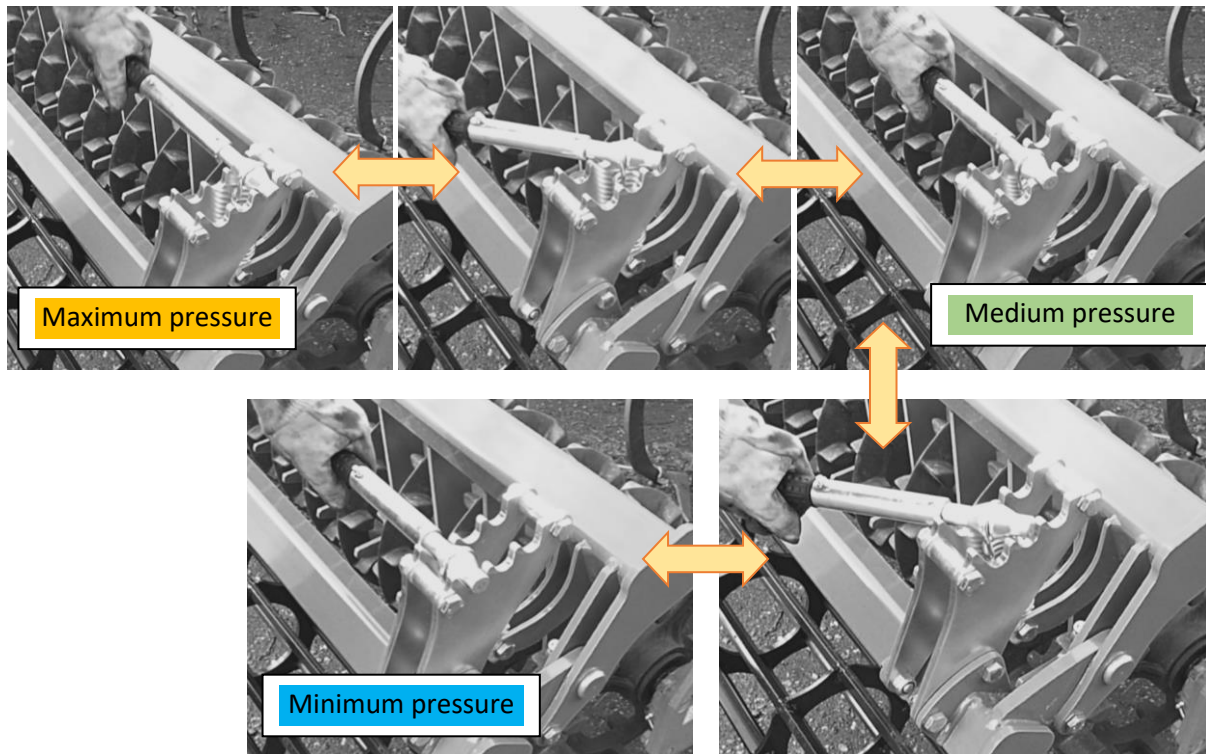

9.7 Pre-stressing tractive ropes

Draw the tractive ropes so that they are curved by about 40 mm up from the imaginary plain by lifting pulleys when the machine is unfolded and standing still.

Fig.24 – Pre-stressing of the tractive rope



10. FIELD WORK POSSIBILITIES FOR THE MACHINE

TURNING AT PLOUGH TURNING END

When working, it is not required to lift or shallow the machine at plough turning ends. However, always turn the machine in adequate curves so that the rear part of the working section located in the internal side of the turning curve does not reverse.

Working without the GPS navigation. Turns are executed without lifting the machine and plough turning ends are worked lastly.

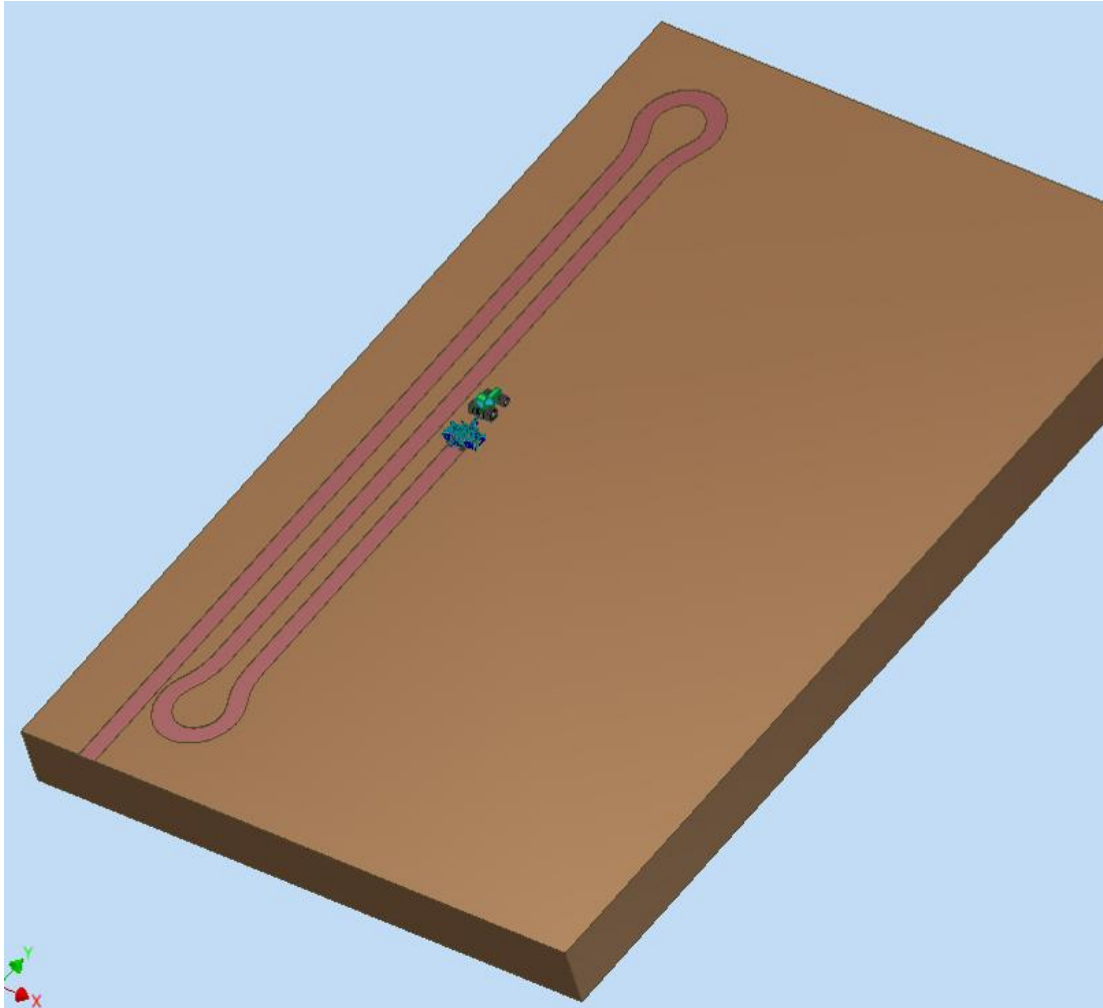

Working with the use of GPS navigation. Turns at the plough turning ends may be larger.

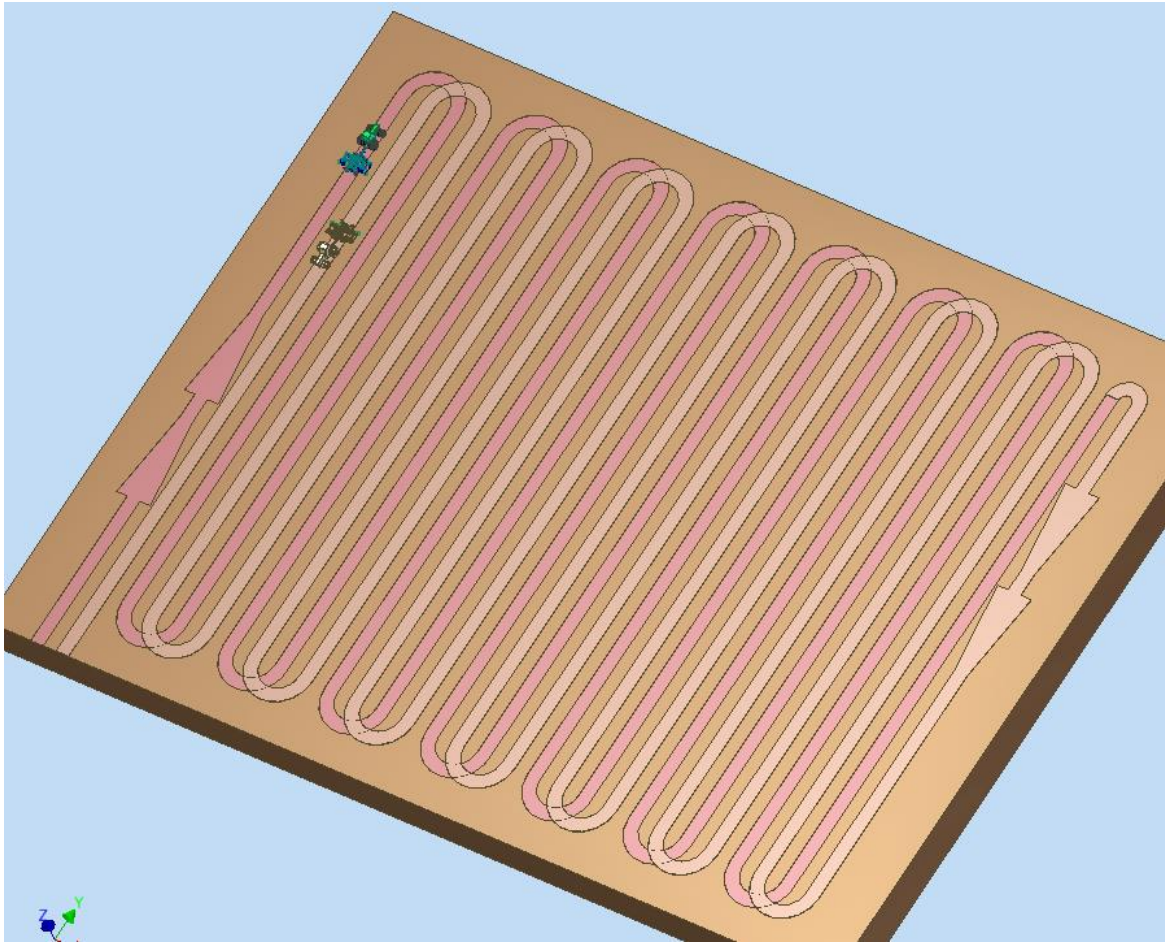

Working on the plough turning end and corners of the land. When reversing, raise the working section by about 45°.

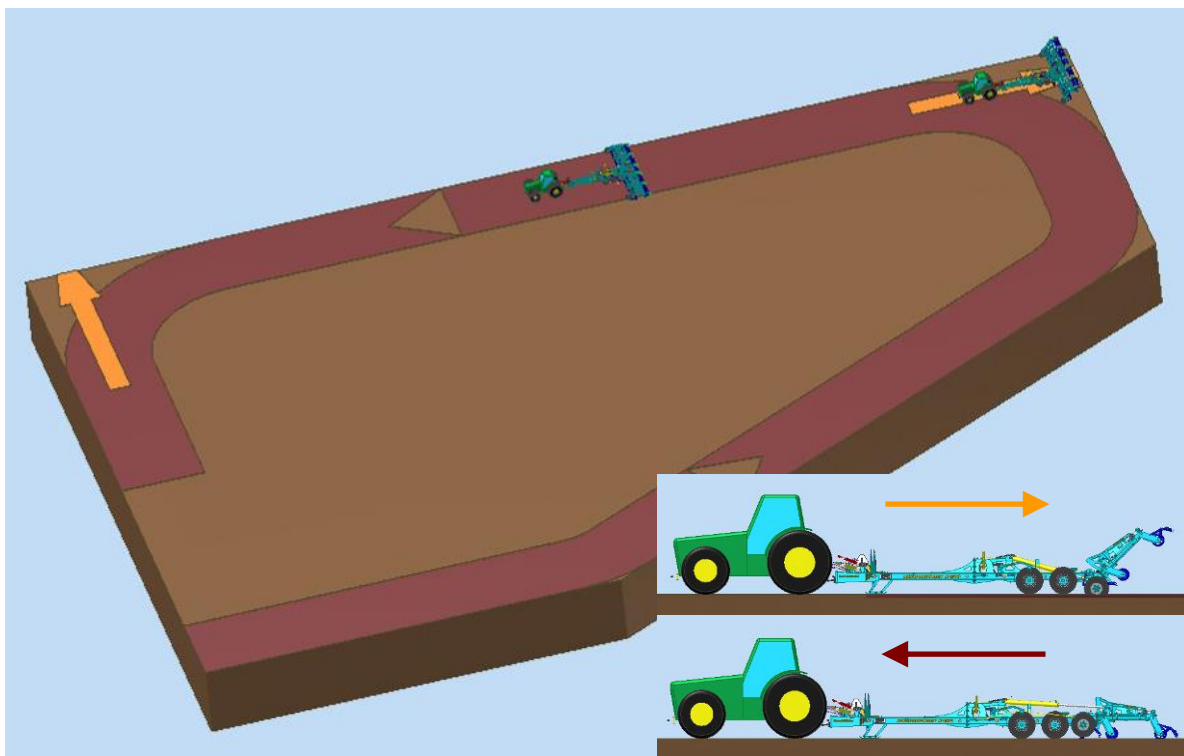

11. BRAKE DISTRIBUTION OF THE MACHINE

- The machine is standardly equipped with a single-circuit two-hose brake system by KNORR BREMSE.
- The rear axle of the chassis is equipped by an automatic hand brake.

Fig.25 – Spring brake piston rod for hand brake



Fig.26 – Hand brake valve control



Fig.27 – Quick coupler for brakes



Fig. 28 – Detail of the brake valve control description

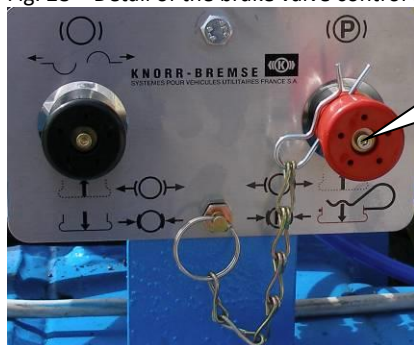

Button for hand brake control
RED BUTTON PUSHED IN = hand brake is not functional
RED BUTTON PULLED OUT = hand brake is activated

12. EXCHANGING THE WORKING TOOLS

- When exchanging the working tools, follow the directions given in Chapter L/Page 8. Strictly adhere the prescribed procedure.
- The machine design enables operator to replace the duckfoot shares with a drag by chisel-shaped shares and vice versa. To replace them, drive out the pull-rod pins, remove the original duckfoot shares and fix the new sections (See Fig. 29).

Fig. 29 – Diagram of Joints Intended for Replacing the Share Sections

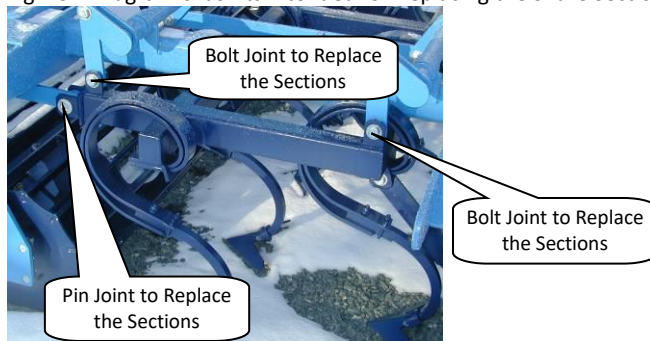

- The machine design enables operators to replace the rear bar rollers with drags by the Crosskill rollers and vice versa. To replace the rollers, dismount the bearings from the supporting frames of the machine, pull them down from the shafts of the original roller and put them on the new roller. The new roller provided with the bearings must then be mounted in the supporting frames.
- All and any replacements of the working tools should be made in a service shop and all the labour-protection rules mentioned in Chapters C/Page 5, K/Page 7-8 and L/Page 8 should be strictly observed.

12.1 Replacement of the working roller bearings

- Always follow the safety regulations and directives when replacing the bearings of rollers.

- The machine must be aggregated with the tractor according to Chapter “6./p.22” when replacing the bearings. The tractor engine must be switched off for the replacement of bearings and the operator, or repairman, must prevent any access to unauthorised persons to the tractor.
- Only replace the roller bearings on a solid and flat ground and when the machine is in standstill.
- In the case of leaks in the tractor hydraulic system, you are required to provide mechanical supports under the machine drawbar.

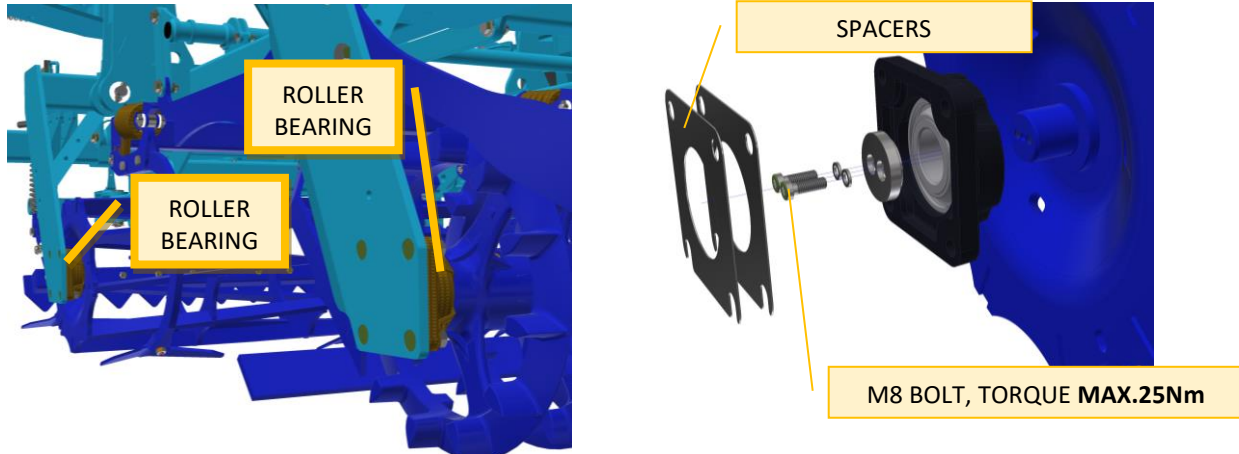

12.1.1 Using spacer

- The spacers are used for defining production tolerances. Therefore, they do not have to be always used.
 - Mount the house bearings to the rollers
 - Insert the roller with the bearings between the frame side plates and assess whether you need to use the SPACERS

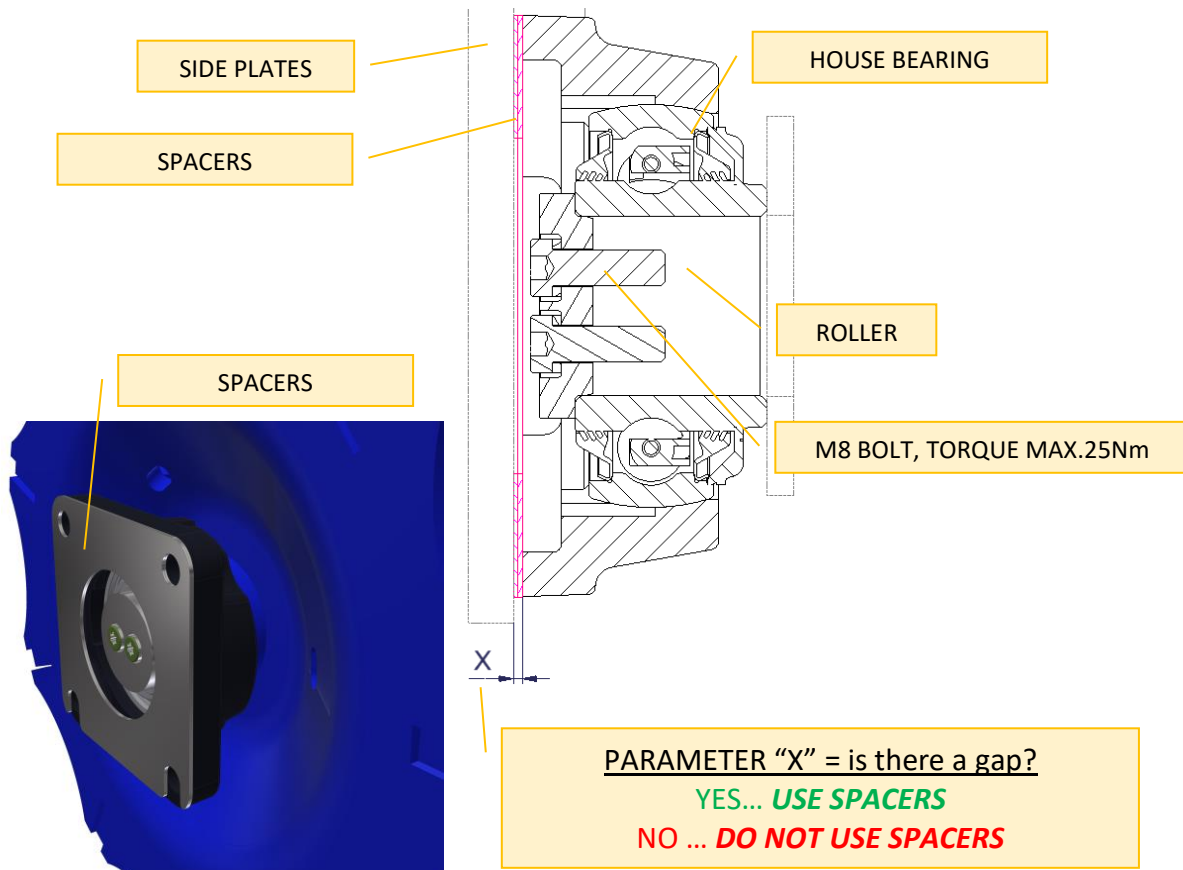

13. MAINTENANCE AND REPAIRS

- When making any repairs, strictly observe the labour-protection rules mentioned in Chapters A through N / Pages 4 through 11.
- After first 20 hours and before each use, check that all screw and other assembly joints are tightened well.
- Lubricate the machine in the lubrication points according to the lubrication chart.
- Check the wear and tear of the working tools from time to time. If worn and torn excessively, replace them by new ones.
- Setting, cleaning and lubricating operations may only be carried out at rest. The tractor engine must be turned off and secured against starting.
- If the work is to be done on the lifted machine, suitable supports placed in marked points or other suitable points must be used.
- When setting, maintaining or repairing the machine, secure reliably those parts of the machine that could cause accidents by falling or moving.
- If hoisted with a suspension lifting mechanism (a crane), hang the machine in the marked points only. These points are marked with the "chain".
- Replace the worn ploughshares either when the machine is folded into the transport position or directly in the field, if necessary. For that you need to tip the working section so that it rests on the auxiliary wheels (see Fig. 30, 31).

Fig. 30 – Transport position for ploughshare section replacement

Fig.31 – Working section for ploughshare replacement in the field



The section must be supported to prevent an unprompted fall during any manipulation or repair



- When a defect or damage appears, turn off the tractor engine immediately, secure it against undesired start up and motion. Only then can you start to repair it.
- Use solely the original spare parts for repairs. Use the appropriate tools and protectives.
- If you are about to arc-weld and if the machine is coupled with the tractor, disconnect the alternator and accumulator feeding cables.
- Check tire pressure and tire condition regularly. Tire repairs and replacements should be made in a specialized workshop.
- Keep the machine clean.

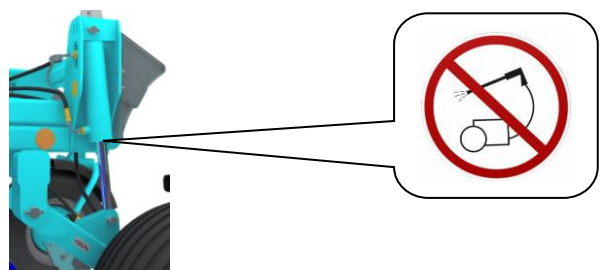
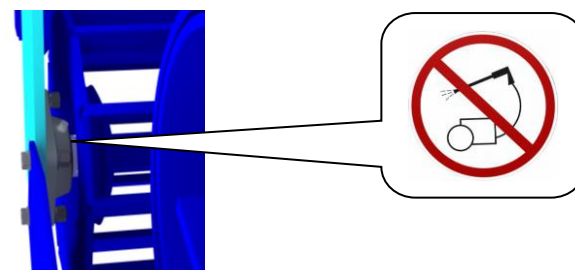
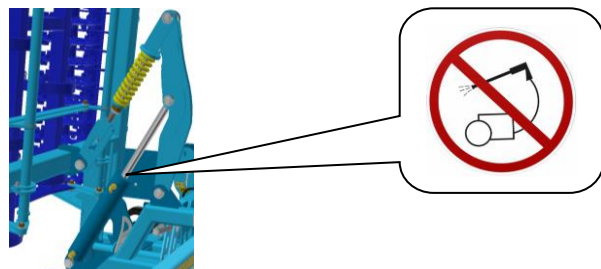
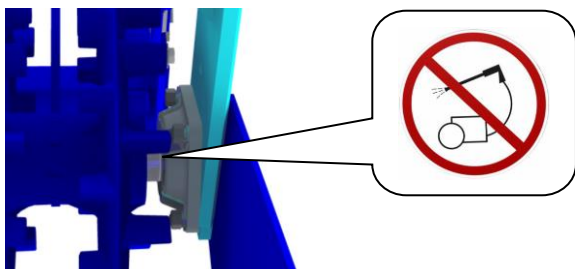

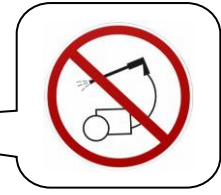
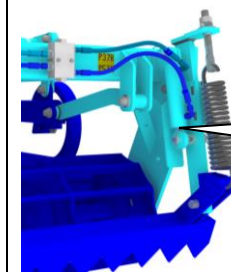
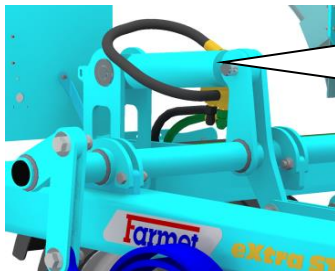

MAINTENANCE PLAN

Perform the planned maintenance according to the instructions:

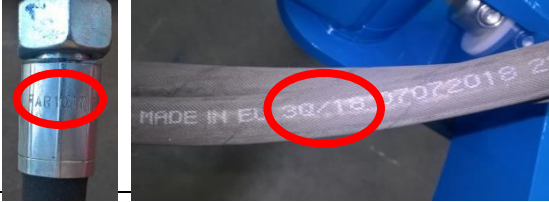
Maintenance Task	Daily (season)	Once a week	Before season	After season	Time interval
Machine in general					
<ul style="list-style-type: none"> Visual inspection of the machine Checking for any undesirable sounds, vibrations and excessive wear 	X				
<ul style="list-style-type: none"> Checking crucial nodes: pins, bearings, rollers, working parts 	X		X	X	
<ul style="list-style-type: none"> Machine cleaning Storing the machine under roof, if possible Recording the mileage of the machine/season (ha) 		X		X	
<ul style="list-style-type: none"> Comprehensive inspection Checking the frame 	X			X	
	Do not use a high-pressure cleaner or direct stream of water to clean the hydraulic rollers, bearings, electric and electronic parts. The seals and bearings are not waterproof at high pressure.				
Hydraulic system					
Checking the function, tightness, mounting and worn spots of all hydraulic parts and hoses		X	X		
Hydraulic hoses – replacement: <ul style="list-style-type: none"> Damaged external casing of the hose (mechanically or blistered) Fluid seepage (especially the end piece) Bumps or blisters on the hose Deformed or corroded end piece Loose end piece – the hose spins 	X			X	
Hydraulic hoses - replacement: <ul style="list-style-type: none"> Expired service life of the hose 					6 years
					

!!! PREVENTION means removing the problem according to the plan, outside the season, without stress and comfortably before a secondary problem, an accident or a health hazard arises.

MAINTENANCE PLAN

Perform the planned maintenance according to the instructions:

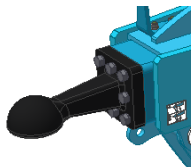
Maintenance Task	Daily (season)	Once a week	Before season	After season	Time interval						
Bolt connections											
Visual inspection of bolt and hydraulic joints, tighten any loose joints using a corresponding torque (see the torque chart)	X			X							
Towing lug – check, tighten if needed <table border="1" data-bbox="220 616 526 694"> <tr> <td>M16 - 10.9.</td> <td>300 Nm</td> </tr> <tr> <td>M20 - 10.9.</td> <td>560 Nm</td> </tr> </table> 	M16 - 10.9.	300 Nm	M20 - 10.9.	560 Nm		X	X				
M16 - 10.9.	300 Nm										
M20 - 10.9.	560 Nm										
Wheels – tighten all wheel nuts. <ul style="list-style-type: none"> • First time: after 10 hours of operation • Wheel replacement: after 10 hours of operation <table border="1" data-bbox="228 846 513 947"> <tr> <td>M 18 x 1.5</td> <td>300 Nm</td> </tr> <tr> <td>M 20 x 1.5</td> <td>400 Nm</td> </tr> <tr> <td>M 22 x 1.5</td> <td>500 Nm</td> </tr> </table>	M 18 x 1.5	300 Nm	M 20 x 1.5	400 Nm	M 22 x 1.5	500 Nm		X	X		
M 18 x 1.5	300 Nm										
M 20 x 1.5	400 Nm										
M 22 x 1.5	500 Nm										
Brake system											
Brake line and hoses – check the function, tightness, mounting and clamping, or breaking	X		X	X							
Brake components – check the function, tightness, mounting	X		X	X							
Air nozzle – drain using the draining valve		X		X							
Draining valve – check the function, clean and replace sealing			X	X							
Pipe filter – clean			X	X							
Brake/parking brake – check the function, escapement setting 25-45mm	X										
Brake lining – check the condition of the brake lining, min. thickness of 3mm				X							
Wheels/axle											
Checking the tyre pressure											
Transport axle K500-1000PS	19.0/45-17 144 A8 pressure 350 kPa	X			X						
	19.0/45-17 148 A8 pressure 330 kPa										
	19.0/45-17 152 A8 pressure 390 kPa										
	19.0/45-17 157 A8 pressure 475 kPa										
	500/50-17 149 A8 pressure 300 kPa										
	500/50-17 154 A8 pressure 300 kPa										
	500/50-17 155 A8 pressure 300 kPa										
Transport axle bearings – check and adjust allowance if needed (in the workshop)				X							

MAINTENANCE PLAN

Perform the planned maintenance according to the instructions:

Maintenance Task	Daily (season)	Once a week	Before season	After season	Time interval
Electric cables					
Check for any damage, replace if needed		X	X		
Safety measures					
Lighting and safety hatched boards – check the condition, function and cleanliness	X		X		
Hazard and safety labels – check that they are installed and legible		X			
Machine lubrication plan					
Drawbar joint / lifting loop – grease	X			X	
Handbrake bolt – grease or suitable oil	X			X	
Axle bearings – grease with Lithium content – check, refill if needed				X	
After season					
Entire machine					
<ul style="list-style-type: none"> ● Treat and clean the machine; do not spray oil or similar agents on the plastic parts ● Spray the piston-rods of the hydraulic cylinders with suitable anti-corrosion agents ● Check the tightness of all bolt and plug-in connections (see the torque chart) ● Check for any damage of the electric cables and replace if needed 					
Brake system					
<ul style="list-style-type: none"> ● Preserve the anti-freeze fluid for air-brake systems (about 0.1l), ethanol-free, before the last ride, use fluid recommended by the tractor manufacturer. ● Secure the machine against movement by Scotch blocks. ● Release the parking brake, release air from the air nozzle and close the brake lines. The service brake must be released during winter so that it does not get stuck on the brake drum 					
Points of lubrication					
Grease the points of lubrication according to the lubrication plan, use grease KP2P-20 Likx, under DIN 51 502					
<p>!!! PREVENTION means removing the problem according to the plan, outside the season, without stress and comfortably before a secondary problem, an accident or a health hazard arises.</p>					

14. LUBRICATION PLAN FOR THE MACHINE

Tab. 5 – Places and intervals of lubrication

PLACE FOR LUBRICATION		INTERVAL	LUBRICANT
Control Handle	Fig.32	- Daily - Before starting the work with the machine - After finishing the work with the machine before shutting it down - Keep required lubrication interval	- Plastic lubricant DIN 51 502 1) K EP2 - 30 2) KP2P-20 Likx
Piston rod bearings location	Fig.33		
Pins			

Fig.32-Control Handle

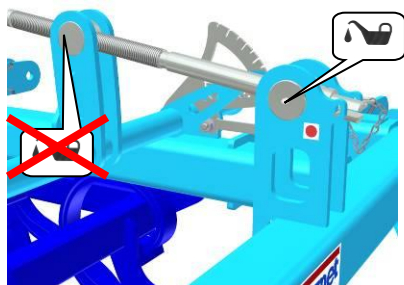
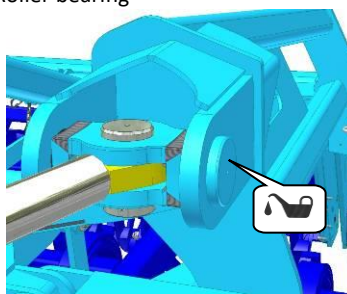

Fig.33 – Roller bearing



15. ENVIRONMENTAL PROTECTION

- Check the tightness of the hydraulic system regularly.
- Replace or repair hydraulic tubes or other parts of the hydraulic system showing signs of damage, before oil starts to leak.
- Check the condition of hydraulic tubes and execute their timely replacement. The usable life of hydraulic tubes also includes the storage time.
- Treat oils and lubricants according to valid acts and regulations on wastes.

16. MACHINE DISPOSAL AFTER SERVICE LIFE EXPIRY

When disposing the machine follow the instructions given under **M**/Page 8.

17. SERVICES AND WARRANTY CONDITIONS

17.1 SERVICES

Servicing is secured by the dealer after consulting with the manufacturer, possibly directly by the manufacturer. Spare parts then using the sales network by individual sellers in the entire country. Use only the spare parts according to the spare parts catalogue officially issued by the manufacturer.

17.2 ZÁRUKA

- 17.2.1** The manufacturer provides a warranty of 24 months for these machine parts: main frame, axle, and machine tow bar. For other parts of the machine, the manufacturer provides a warranty of 12 months. The warranty is provided from the date of sale of the new machine to the end user (consumer).
- 17.2.2** The warranty applies to hidden defects that will show in the warranty period with proper use of the machine and while fulfilling the conditions stated in the operating manual.
- 17.2.3** The warranty does not apply to wearable spare parts, i.e. regular mechanical wear and tear of replaceable parts of the working sections (shares, edges, etc.).
- 17.2.4** The warranty does not apply to indirect consequences of possible damage, such as service life decrease etc.
- 17.2.5** The warranty is bound to the machine and is not void upon an owner change.
- 17.2.6** The warranty is limited to the disassembly and assembly, possibly replacement or repair of the defective part. The decision, whether to replace or repair the defective part, is up to the contractual workshop of Farmet.
- 17.2.7** During the warranty period, only the authorised servicing technician of the manufacturer may perform repairs or other interventions into the machine. In the opposite case, the warranty will not be acknowledged. This provision does not apply to the replacement of wearable spare parts (see point 17.2.3).
- 17.2.8** The warranty is conditioned by using the genuine spare parts of the manufacturer.

ⒸZ ES PROHLÁŠENÍ O SHODĚ
ⒸGB CE CERTIFICATE OF CONFORMITY
ⒸD EG-KONFORMITÄTSERKLÄRUNG
ⒸF DÉCLARATION CE DE CONFORMITÉ
ⒸRU СЕРТИФИКАТ СООТВЕТСТВИЯ ЕС
ⒸPL DEKLARACJA ZGODNOŚCI WE

1. ⒸZ My ⒸGB We ⒸD Wir ⒸF Nous ⒸRU Мы ⒸPL My: **Farmet a.s.**
Jiřinková 276
552 03 Česká Skalice
Czech Republic
DIČ: CZ46504931
Tel/Fax: 00420 491 450136

ⒸZ Vydáváme na vlastní zodpovědnost toto prohlášení. ⒸGB Hereby issue, on our responsibility, this Certificate. ⒸD Geben in alleiniger Verantwortung folgende Erklärung ab. ⒸF Publiions sous notre propre responsabilité la déclaration suivante. ⒸRU Под свою ответственность выдаем настоящий сертификат. ⒸPL Wydajemy na własną odpowiedzialność niniejszą Deklarację Zgodności.

2. ⒸZ Strojní zařízení: - název : **Polonesený kompaktomat**
ⒸGB Machine: - name : **Semi-Mounted unfolding Kompaktomat**
ⒸD Fabrikat: - Bezeichnung : **Klappbare Aufsattelgeräte Kompaktomat**
ⒸF Machinerie: - dénomination : **Compactomats de semi-portage basculants**
ⒸRU Сельскохозяйственная машина: - наименование : **Полунавесной складной компактомат**
ⒸPL Urządzenie maszynowe: - nazwa : **Półzawieszony opuszczany Kompaktomat**

- typ, type : **K 1250 PS**
- model, modèle : **K 1250 PS II.**
- ⒸZ výrobní číslo :
- ⒸGB serial number :
- ⒸD Fabriknummer :
- ⒸF n° de production :
- ⒸRU заводской номер :
- ⒸPL numer produkcyjny :

3. ⒸZ Příslušná nařízení vlády: č.176/2008 Sb. (směrnice 2006/42/ES). ⒸGB Applicable Governmental Decrees and Orders: No.176/2008 Sb. (Directive 2006/42/ES). ⒸD Einschlägige Regierungsverordnungen (NV): Nr.176/2008 Slg. (Richtlinie 2006/42/ES). ⒸF Décrets respectifs du gouvernement: n°.176/2008 du Code (directive 2006/42/CE). ⒸRU Соответствующие постановления правительства: № 176/2008 Сб. (инструкция 2006/42/ES). ⒸPL Odpowiednie rozporządzenia rządowe: nr 176/2008 Dz.U. (Dyrektywa 2006/42/WE).

4. ⒸZ Normy s nimiž byla posouzena shoda: ⒸGB Standards used for consideration of conformity: ⒸD Das Produkt wurde gefertigt in Übereinstimmung mit folgenden Normen: ⒸF Normes avec lesquelles la conformité a été évaluée: ⒸRU Нормы, на основании которых производилась сертификация: ⒸPL Normy, według których została przeprowadzona ocena: ČSN EN ISO 12100, ČSN EN ISO 4254-1.

ⒸZ Schválil ⒸGB Approve by dne: 01.06.2012
ⒸD Bewilligen ⒸF Approuvé
ⒸRU Утвердил ⒸPL Uchwalif

p. Gavlas Dušan
technický ředitel
Technical director

Farmet a.s.
Jiřinková 276
552 03 Česká Skalice
DIČ CZ46504931
3A

V České Skalici dne: 01.06.2012

Ing. Karel Žďárský
generální ředitel společnosti
General Manager



ⒸZ ES PROHLÁŠENÍ O SHODĚ
ⒸGB CE CERTIFICATE OF CONFORMITY
ⒸD EG-KONFORMITÄTSERKLÄRUNG
ⒸF DÉCLARATION CE DE CONFORMITÉ
ⒸRU СЕРТИФИКАТ СООТВЕТСТВИЯ ЕС
ⒸPL DEKLARACJA ZGODNOŚCI WE

1. ⒸZ My ⒸGB We ⒸD Wir ⒸF Nous ⒸRU Мы ⒸPL My: **Farmet a.s.**
Jiřínková 276
552 03 Česká Skalice
Czech Republic
DIČ: CZ46504931
Tel/Fax: 00420 491 450136

ⒸZ Vydáváme na vlastní zodpovědnost toto prohlášení. ⒸGB Hereby issue, on our responsibility, this Certificate. ⒸD Geben in alleiniger Verantwortung folgende Erklärung ab. ⒸF Publiions sous notre propre responsabilité la déclaration suivante. ⒸRU Под свою ответственность выдаем настоящий сертификат. ⒸPL Wydajemy na własną odpowiedzialność niniejszą Deklarację Zgodności.

2. ⒸZ Strojní zařízení: - název : **Polonesený kompaktomat**
ⒸGB Machine: - name : **Semi-Mounted unfolding Kompaktomat**
ⒸD Fabrikat: - Bezeichnung : **Klappbare Aufsattelgeräte Kompaktomat**
ⒸF Machinerie: - dénomination : **Compactomats de semi-portage basculants**
ⒸRU Сельскохозяйственная машина: - наименование : **Полунавесной складной компактомат**
ⒸPL Urządzenie maszynowe: - nazwa : **Półzawieszony opuszczany Kompaktomat**

- typ, type : **K 1570 PS**
- model, modèle : **K 1570 PS II.**
- ⒸZ výrobní číslo :
- ⒸGB serial number :
- ⒸD Fabriknummer :
- ⒸF n° de production :
- ⒸRU заводской номер :
- ⒸPL numer produkcyjny :

3. ⒸZ Příslušná nařízení vlády: č.176/2008 Sb. (směrnice 2006/42/ES). ⒸGB Applicable Governmental Decrees and Orders: No.176/2008 Sb. (Directive 2006/42/ES). ⒸD Einschlägige Regierungsverordnungen (NV): Nr.176/2008 Slg. (Richtlinie 2006/42/ES). ⒸF Décrets respectifs du gouvernement: n°.176/2008 du Code (directive 2006/42/CE). ⒸRU Соответствующие постановления правительства: № 176/2008 Сб. (инструкция 2006/42/ES). ⒸPL Odpowiednie rozporządzenia rządowe: nr 176/2008 Dz.U. (Dyrektywa 2006/42/WE).

4. ⒸZ Normy s nimiž byla posouzena shoda: ⒸGB Standards used for consideration of conformity: ⒸD Das Produkt wurde gefertigt in Übereinstimmung mit folgenden Normen: ⒸF Normes avec lesquelles la conformité a été évaluée: ⒸRU Normы, на основании которых производилась сертификация: ⒸPL Normy, według których została przeprowadzona ocena: ČSN EN ISO 12100, ČSN EN ISO 4254-1.

ⒸZ Schwälil ⒸGB Approve by dne: 01.06.2012
ⒸD Bewilligen ⒸF Approuvé
ⒸRU Утвердил ⒸPL Uchwalil

p. Gavlas Dušan
technický ředitel
Technical director

Farmet a.s.
Jiřínková 276
552 03 Česká Skalice
DIČ CZ46504931
3P

V České Skalici dne: 01.06.2012

Ing. Karel Žďárský
generální ředitel společnosti
General Manager

