

OPERATING MANUAL

FANTOM

FX 300 N | FX 350 N

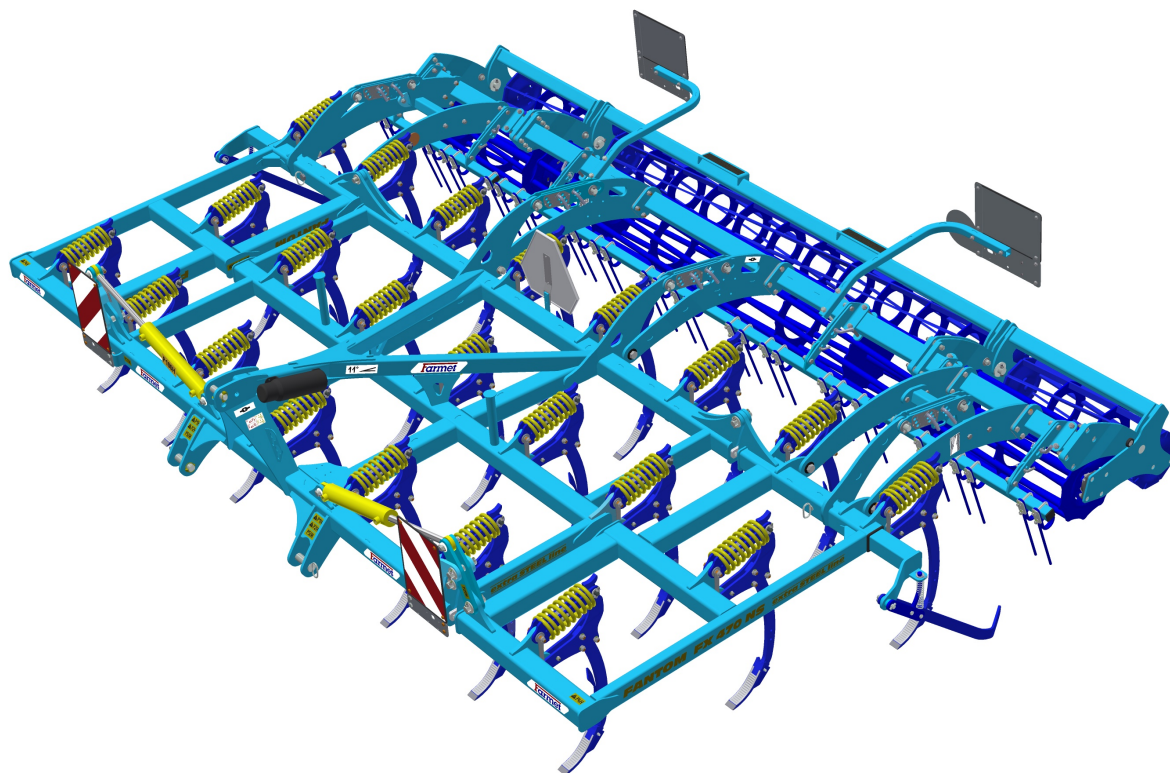

Edition: **3**

Effective from: **1.5.2019**

FARMET a.s.
Jiřinková 276
552 03 Česká Skalice, CZ

phone: +420 491 450 111
fax: +420 491 450 136
GSM: +420 774 715 738

IČ: 46504931
DIČ: CZ46504931

www.farmet.cz
e-mail: farmet@farmet.cz

Prepared by: Technical Department, Farmet a.s.
on 20.05.2019, changes reserved

PREFACE

Dear customer,

The agricultural machine you have purchased is a high-quality product of Farmet a.s. Česká Skalice.

You can fully utilise the advantages of your machine after thoroughly studying the operating manual.

The serial number of the machine is punched on the production label and written in the operating manual (Your Machine Characteristics). This machine serial number must be stated whenever ordering spare parts for possible repairs. The production label is located on the frame.

Use only spare parts for these machines according to the **Spare parts catalogue** officially issued by the manufacturer, Farmet a.s. Česká Skalice.

Possibilities of Use of the Cultivator

The **FANTOM** cultivator is designed for cultivation of all types of soils up to a processing depth of 15 cm.

Your Machine Characteristics :

MACHINE TYPE :

MACHINE SERIAL NUMBER :

SPECIAL DESIGN OR ACCESSORIES :

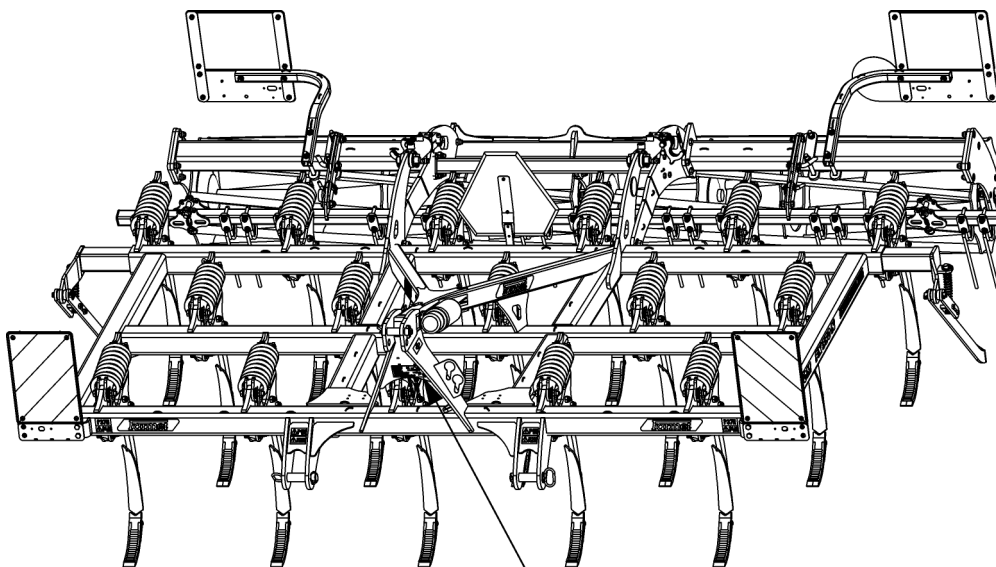

IMPORTANT

READ CAREFULLY BEFORE USE

KEEP FOR FUTURE REFERENCE

Contents

PREFACE	3
1 MACHINE LIMIT PARAMETERS	7
1.1 Technical parameters.....	7
1.2 Safety statement.....	7
2 GENERAL INSTRUCTIONS FOR USE	8
3 MACHINE TRANSPORT USING TRANSPORT MEANS	10
4 MACHINE HANDLING USING LIFTING EQUIPMENT	11
5 WORK SAFETY LABELS	12
6 DESCRIPTION.....	15
6.1 Working parts of the machine	15
7 MACHINE ASSEMBLY AT THE CUSTOMER.....	16
8 COMMISSIONING.....	17
8.1 Agregation to a tractor	18
8.2 Description of the share/chisel replacement	19
9 REAR ACCESSORIES	20
9.1 Setting g levelling	22
9.1.1 Setting the angle of rear levelling	22
10 MACHINE TRANSPORT ON ROADS	23
11 MACHINE ADJUSTMENT.....	24
11.1 Adjusting the working depth of the machine	25
11.2 Setting side deflectors.....	28
11.3 Share securing	29
12 MACHINE MAINTENANCE AND REPAIRS	30
13 MACHINE STORAGE.....	31
14 MACHINE LUBRICATION SCHEDULE.....	32
15 ENVIROMENTAL PROTECTION	33
16 MACHINE DISPOSAL AFTER SERVICE LIFE EXPIRY.....	34
17 SERVICING AND WARRANTY CONDITIONS	35
17.1 Servicing	35
17.2 Warranty	35

1 MACHINE LIMIT PARAMETERS

- The machine is designed for soil ploughing up to a depth of 15 cm when agricultural soil cultivation. Another type of use exceeding the determined purpose is forbidden.
- The machine is only operated by one person – the tractor operator.
- Machine operator must not use the machine in a different way, especially:
 - Transport of persons and animals on the machine structure,
 - Transport of burdens on the machine structure,
 - Aggregation of the machine with another towing equipment than stated in Chapter „8.1“.

1.1 Technical parameters

PARAMETERS	FANTOM FX 300 N	FANTOM FX 350 N
Working width	3 m	3,5 m
Transport width	3 m	3,5 m
Transport height	1,4 m	
Machine total length	3,4 m	
Working depth	4 – 15 cm	
Number of shares	13	16
Working performance	2,4 – 3,6 ha/h	2,8 – 4,2 ha/h
Towing means	110–165 kW*	120–180 kW*
Working speed	8 – 12 km/h	
Maximum transport speed	20 km/h	
Maximum slope grade (°)	6	
Machine weight	1120 kg	1220 kg

* Recommended towing means, the real towing force may significantly vary according to the processing depth, soil conditions, land slope, working body wear and adjustment.

1.2 Safety statement



This warning sign warns about an immediate dangerous situation ending with death or severe injury.







This warning sign warns about a dangerous situation ending with death or severe injury.



This warning sign warns about a situation that may end with a smaller or slight injury. It also warns about dangerous actions related to the activity that could lead to an injury.

2 GENERAL INSTRUCTIONS FOR USE

- The machine is made in accordance with the latest equipment state and approved safety regulations. However, dangers of user or third person injury or machine damage or creation of other material damage may arise during use.
- Use the machine only in a technically sound condition, in accordance with its purpose, aware of possible dangers, and while adhering to the safety instructions of this operating manual! The manufacturer is not liable for damages caused by the use of the machine that is in contradiction with the limit parameters of the machine and with the instructions for the use of the machine. The user bears the risk. Immediately remove especially the failures that may negatively affect safety!
- Machine operation may be performed by a person authorised by the operator under these conditions :
 - It must own a valid driver's licence of the corresponding category,
 - It must be demonstrably familiarised with the safety regulations for work with the machine and must practically master the machine operation,
 - The machine may not be operated by juveniles,
 - It must know the meaning of the safety signs located on the machine. Their respecting is important for safe and reliable machine operation.
- Maintenance and servicing repairs on the machine may only be performed by a person :
 - Authorised by the operator,
 - Educated in the machinery field with knowledge of repairs of similar machines,
 - Demonstrably familiarised with safety regulations for work with the machine,
 - During a repair of a machine connected to a tractor, it must own a driver's licence of the corresponding category.
- Machine operator must secure the safety of other persons when working with the machine or transporting the machine.
- During machine work in the field or during transport, the operator must control the machine from the tractor's cabin.
-  The operator may enter the machine structure only with the machine at rest and blocked against movement, namely only for these reasons :
 - Adjustment of the machine working parts,
 - Repair and maintenance of the machine,
-  When stepping on the machine, do not step on roller, tyres or other rotary parts. Those may turn and you can cause very serious injuries by the subsequent fall.
-  Any changes or modifications of machine may be performed only with written consent of the manufacturer.
For possible damage arisen due to ignoring this instruction, the producer bears no responsibility.
The machine must be maintained equipped with prescribed accessories and equipment including safety marking.
All warning and safety signs must be legible and in their places. In case of damage or loss, these signs must be immediately renewed.
-  The operator must have the Operating Manual with the work safety requirements available at any time when working with the machine.

- The operator must not consume alcohol, medicines, narcotic and hallucinogenic substances that decrease his attention and coordination capabilities while using the machine.
If the operator must use medicines prescribed by a physician or uses freely sold medicines, he must be informed by a physician, whether he is capable of responsible and safe operation of the machine under these circumstances.

Protective equipment

For operation and maintenance use:

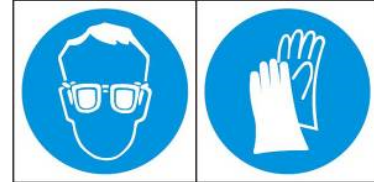

- tight clothes
- protective gloves and goggles against dust and sharp parts of the machine.



3 MACHINE TRANSPORT USING TRANSPORT MEANS

- The transport means designed for machine transport must have the load capacity minimally identical with the weight of the transported machine. The total weight of the machine is stated on the production label.
- The dimensions of the transported machine including the transport means must comply with the valid regulations for road traffic (decrees, laws).
-  • The transported machine must be always fastened to the transport means so that its spontaneous loosening could not happen.
- The carrier is responsible for damage caused by the loosening of incorrectly or insufficiently fastened machine to the transport means.

4 MACHINE HANDLING USING LIFTING EQUIPMENT

- The lifting equipment and tying means designed for handling of the machine must have their load capacity at least identical with the weight of the handled machine.
-  • Machine fastening for handling may only be performed in places designed for that and marked with self-adhesive labels showing the "chain" symbol. 
- After fastening (suspending) at designated points, it is forbidden to move in the space of possible reach of the handled machine.

5 WORK SAFETY LABELS

Warning safety labels serve for operator protection.

General:

- Strictly observe the warning safety labels.
- All safety instructions also apply to other users.
- Upon damage or destruction of the aforementioned "SAFETY LABEL" located on the machine, THE OPERATOR IS OBLIGED TO REPLACE IT WITH A NEW ONE!!!
- The position, appearance and the precise meaning of the work safety labels on the machine are defined in the following tables and the figure .

WARNING SAFETY LABEL	LABEL TEXT	MACHINE POSITION
	<p>Before handling the machine, carefully read the operating manual. Observe the instructions and safety regulations for machine operation during use.</p>	P 1 H
	<p>When connecting or disconnecting, do not step between the tractor and the machine, also do not enter this space, if the tractor and the machine are not at rest and the engine is not turned off.</p>	P 2 H
	<p>Stay out of reach of the drawn-up machine.</p>	P 4 H
	<p>Stay outside the reach of the tractor - agricultural machine set, if the tractor engine is in operation.</p>	P 6 H
	<p>The side extensible disc must be secured with the stopper for transport and during work. The rear twin roller must be secured with the stopper for transport. Before commencing the machine transport, secure the axle with spherical valves against unexpected drop.</p>	P 13 H
	<p>When folding the side frames, do not reach into the space of the machine folding joints. There is a danger of cutting when setting the depth of the machine.</p>	P 20 H





 <p>P 37 H</p>	<p>Travelling and transport on the machine structure is strictly forbidden.</p>	<p>P 37 H</p>
 <p>P 39 H</p>	<p>When working and transporting the machine, maintain safe distance from the electric appliances</p>	<p>P 39 H</p>
 <p>P 42 H</p>	<p>The pressure vessel is under gas and oil pressure. Execute disassembly and repairs only according to the instructions in the manual.</p>	<p>P 42 H</p>
 <p>P 50 H</p>	<p>When folding and unfolding the side frames, stay outside their reach.</p>	<p>P 50 H</p>
 <p>P 52 H</p>	<p>Secure the machine against unwanted movement by positioning on its working bodies (shares).</p>	<p>P 52 H</p>
 <p>P 53 H</p>	<p>Stay outside the reach of the tractor - agricultural machine set, if the tractor engine is in operation.</p>	<p>P 53 H</p>
	<p>It is strictly folding and unfolding the side frames on slopes or inclined surfaces.</p>	<p>P 100 H</p>
 <p>P 101 H</p>	<p>The shown positions of the lever and the function of the hydraulic spherical valve located on the piston rod.</p>	<p>P 101 H</p>

Fig. 1 - Working parts of the machine FANTOM FX 300 N, FX 350 N

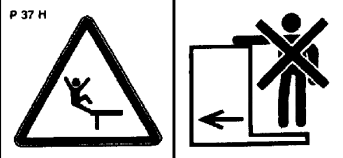
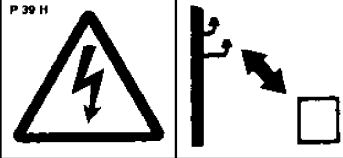
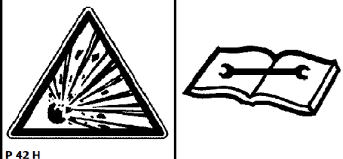

6 DESCRIPTION

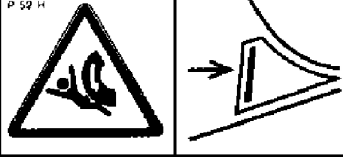
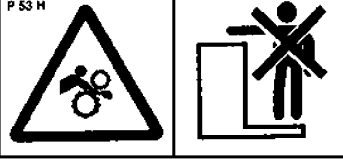
The machine **FANTOM FX 300 N, FX 350 N** is structurally solved as carried. The machine is equipped with TPS 2 and TPS 3 suspension. It consists of a central frame, where the tines with chisels in three rows. The tines are protected against overload with compression springs. The rear frames, equipped with rollers, are also hung on the frames. A row of spring levellers or flexi-boards can be attached to the rear frames.

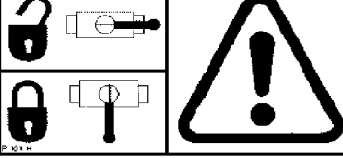
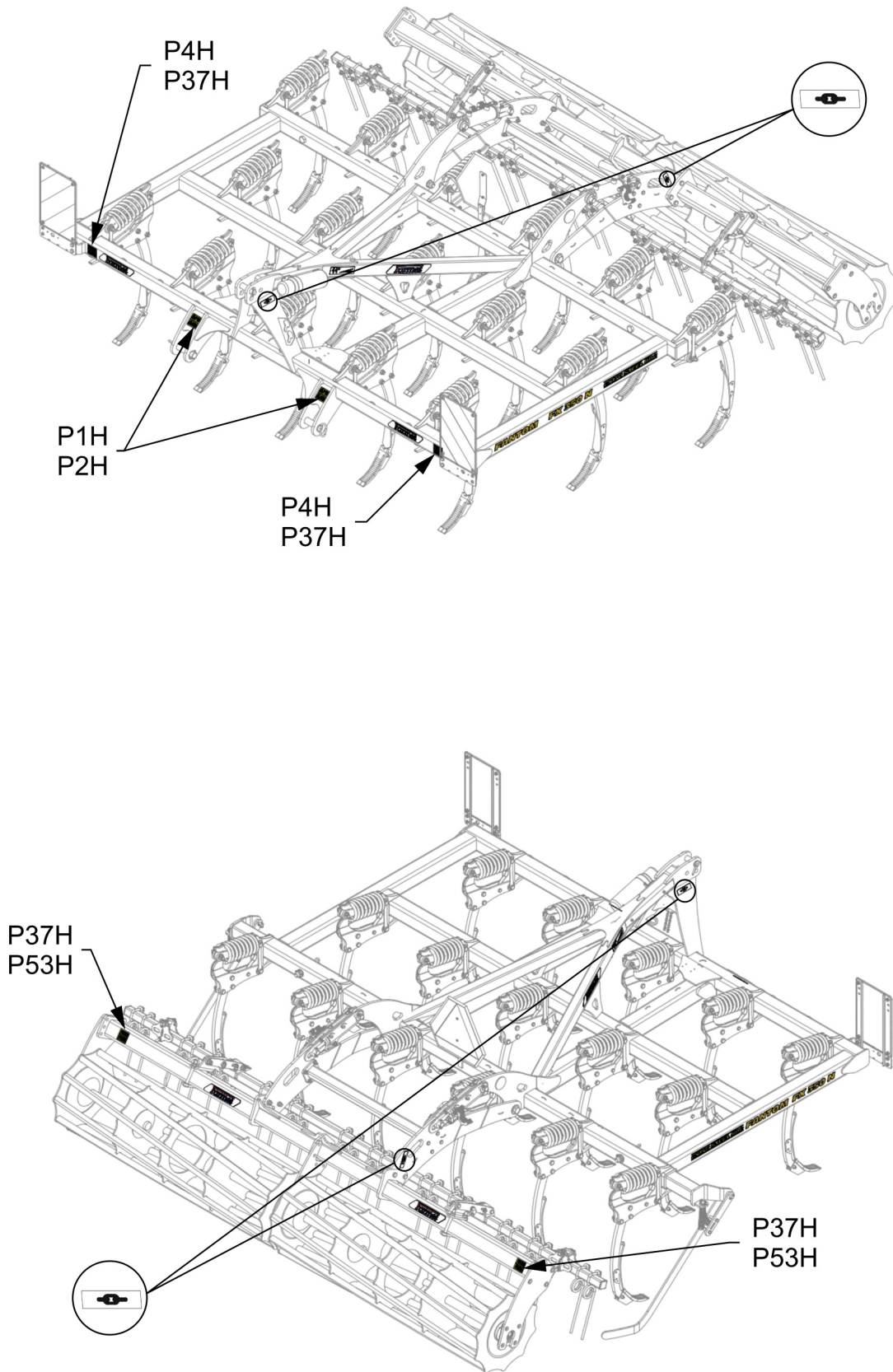
6.1 Working parts of the machine

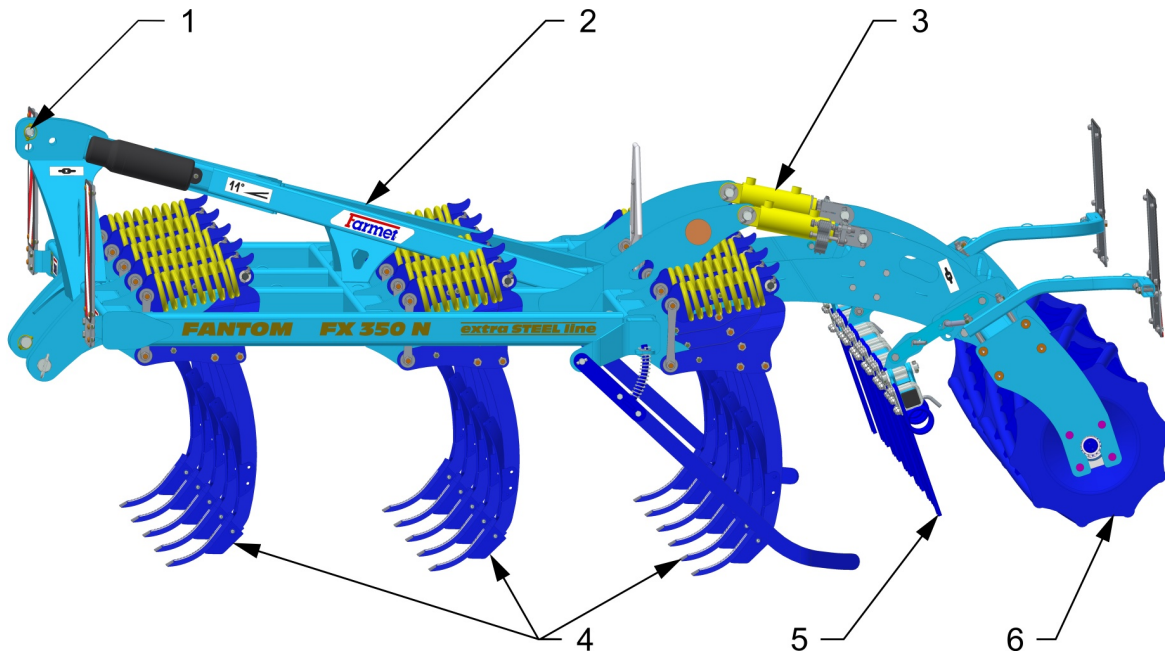

1. TPS tractive suspension
2. Machine framework
3. Setting the depth of the rollers
4. Share section in three rows, chisel shares on tines
5. Spring leveller section
6. Rear roller (see chapter 9)

7 MACHINE ASSEMBLY AT THE CUSTOMER

- The operator must perform the assembly according to the instructions of the producer, best in cooperation with the expert servicing technician determined by the producer.
-  • The operator must secure a functional test of all assembled parts after the completion of the machine assembly.
- The operator must secure that the handling of the machine using lifting equipment during its assembly is in accordance with chapter „4“.

8 COMMISSIONING

- Before taking over the machine, test and check, whether damage occurred during transport and whether all parts contained in the bill of delivery were supplied.



- Before commissioning the machine, carefully read this operating manual, especially Chapters 1–5. Before the first use of the machine, familiarise yourselves with its controls and overall function.
- During work with the machine, observe not only the instructions of this operating manual but also generally valid regulations of work safety, health protection, fire and transport safety, and environmental protection.
- The operator must check the machine before every use (commissioning) from the standpoint of completeness, work safety, work hygiene, fire safety, transport safety, and environmental protection. A machine showing signs of damage must not be commissioned.
- Aggregation of the machine with the tractor is to be performed on a flat and hardened surface.
- When working on slopes, observe the lowest allowable slope grade of the set **TRACTOR - MACHINE**.
- Before starting the tractor motor, check whether no person or animal is in the working space of the set and push the warning sound signal.
- The operator is responsible for the safety and all damage caused by the operation of the tractor and the connected machine.
- The operator is obliged to adhere to the technical and safety regulations of the machine determined by the producer when working.
- The operator is obliged to retract the working bodies of the machine from the ground when turning at the headland.
- The operator is obliged to observe the prescribed working depths and speeds stated in the manual in. chap.1.
- The operator is obliged to lower the machine to the ground and secure the set against movement before leaving the tractor cabin.
- Lower the machine with caution so that the chisels and shares are not damaged by sharp lowering to the ground. Position the machine on a flat ground so that the weight of the machine is evenly transferred to all shares.

8.1 Agregation to a tractor

- The machine can be connected only to a tractor, whose curb weight is identical or higher than the overall weight of the connected machine.
- The machine operator must observe all generally valid regulations of work safety, health protection, fire safety, and environmental protection.
- The operator may connect the machine exclusively to a tractor that is equipped with a rear three-point suspension and a functional undamaged hydraulic system.
- The table of requirements for the towing means for work with the machine:

Requirement for the tractor engine power for the machine FANTOM FX 300 N			110 – 165 kW*
Requirement for the tractor engine power for the machine FANTOM FX 350 N			120 – 180 kW*
Requirement for the tractor's TPS	Spacing of the lower suspension joints (measured at the joint axes)	TPS 2	895 ± 1,5 mm
		TPS 3	895 ± 1,5 mm 1100 ± 1,5 mm
	∅ of the hole of the lower suspension joints for the machine suspension pivots	TPS 2	28,7 – 29,03 mm
		TPS 3	37,4 – 37,75 mm
	∅ of the hole of the upper suspension joint for the machine suspension pivot	TPS 2	25,7 – 25,91 mm
		TPS 3	32 – 32,25 mm

* Recommended towing means, the real towing force may significantly vary according to the processing depth, soil conditions, land slope, working body wear and adjustment.

- Connect the machine using the TPS suspension bar to the lower arms of the rear TPS of the tractor, secure the TPS arms using pins against disconnecting.
- The machine aggregated with the tractor changes the distribution of the weight to the individual axles of the tractor. The weight of the front axle is reduced and therefore the controllability gets worse. It also affects braking properties.



When connecting, no persons may stay in the space between the tractor and the machine.

8.2 Description of the share/chisel replacement

- If the ploughshare / chisel wear is high, this working tool must be replaced
- Tools required for replacement:
 - **HAMMER**
 - **DRIVER - 12 mm**
- The installation is the same for all types of working parts



The machine is sufficiently lifted so that the working part can be removed from the shoe.



Using the prepared tools, drive the spring pin out and remove the ploughshare from the shoe.



Drive a new working part in the shoe and secure it with the spring pin 12x50mm.

9 REAR ACCESSORIES

Various types of rollers can be installed on the machine:

- Tube roller TR:

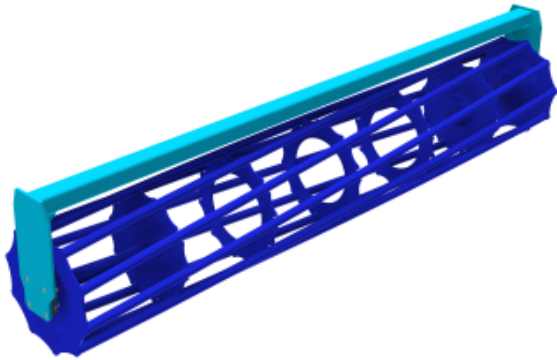

Diameter 500 mm
Weight 90 kg/m

- Ring roller RR:

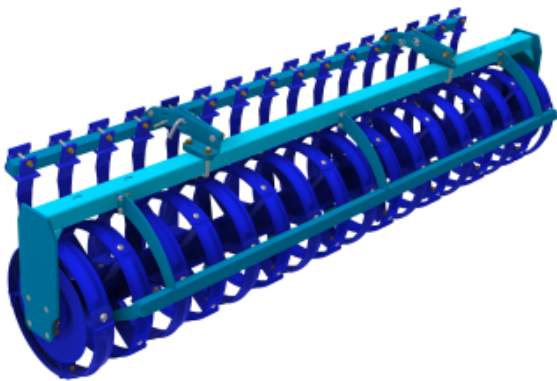

Diameter 520 mm
Weight 160 kg/m

- V-Ring roller VR:

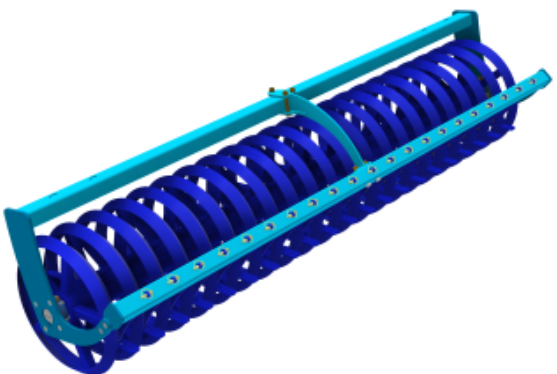

Diameter 580 mm
Weight 175 kg/m

- Double roller DR:

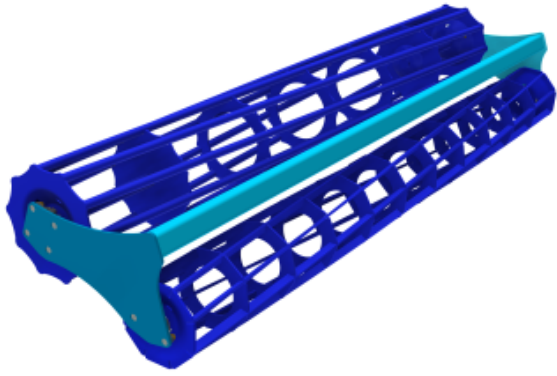

Diameter 400/350 mm
Weight 120 kg/m

- Disk roller SDR:

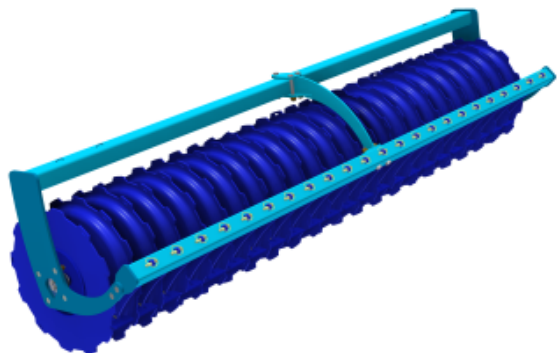

Diameter 580 mm
Weight 220 kg/m

Roller	TR	RR	VR	DR	SDR
Crumbling	●●●○	●●●○	●●●○	●●●○	●●●○
Stamping	●●●○	●●●●	●●●●	●●●○	●●●●
Depth guiding	●●●○	●●●●	●●●●	●●●●	●●●●
Resistance against clogging	●○○○	●●●●	●●●●	●●●○	●●●○
Suitability for stony soils	●●●○	●●●○	●●●○	●●●○	●●●○
Suitability for wet soils	●○○○	●●●●	●●●●	●●○○	●●●●
Heavy soils	●●○○	●●●●	●●●●	●●●●	●●●●
Medium soils	●●●○	●●●●	●●●●	●●●●	●●●●
Light soils	●●●●	●●●●	●●●●	●●●●	●●●○

9.1 Setting g levelling

9.1.1 Setting the angle of rear levelling

Set levelling according to the current soil conditions with regard to the wear condition of the levelling rods.

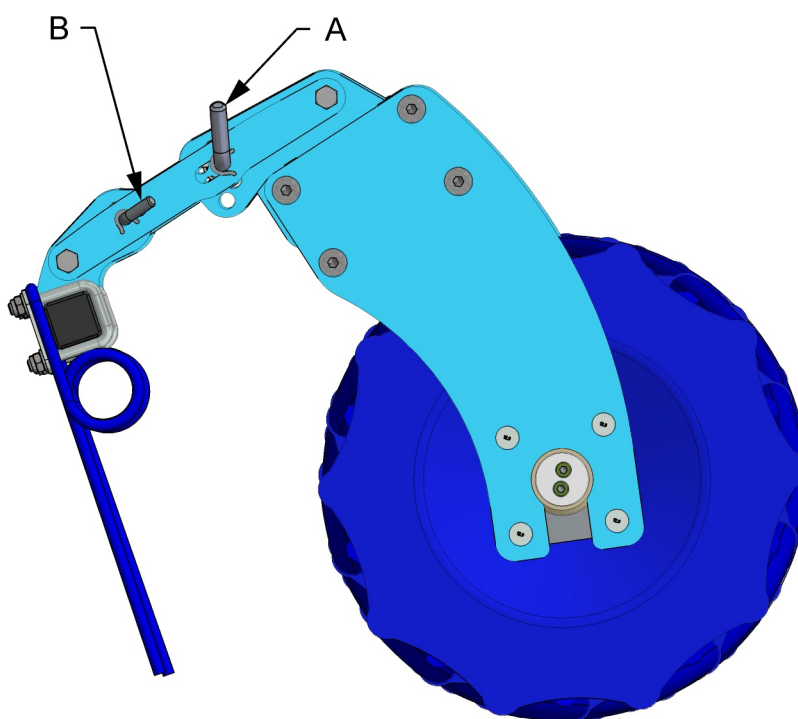
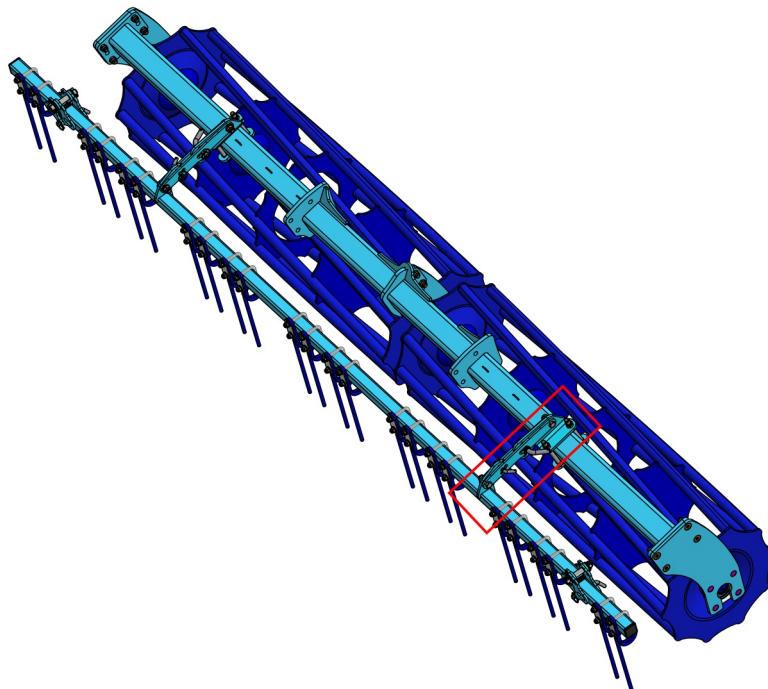

A – Using the rear pin, set the required height of the levelling rods – set the pin at the same position in all points

B – Using the front pin, set the suitable angle of the levelling rods – set the pin at the same position in all points

10 MACHINE TRANSPORT ON ROADS

Transport position of FANTOM FX 300 N, 350 N



- Connect the machine by suspending on the tractor using the three-point suspension equipment .
- The machine must be equipped with removable shields with marking of contours, functional lighting, and the board of the rear marking for slow vehicles (according to EHK No. 69).
- The lighting must be activated during travelling on roads.
- The tractor must be equipped with a special light device of an orange colour, which must be activated during travelling on roads.
- The maximum transport speed during travelling on roads is **20 kph**.
- Secure the lower shoulders of the tractor TPS from side swing.



Ban of transport with decreased visibility !!!

- The operator is obliged to pay increased attention during transport on roads, due to the transport dimensions of the machine.
- The operator must observe the valid regulations for transport on roads (laws, decrees) after connecting the machine to the tractor, for reason of a change of the axle load. The driving properties of the set also change depending on the terrain nature, adapt the manner of driving to these conditions.
- The operator is obliged to present the machine certificate of roadworthiness as needed, according to the valid regulations for road traffic (decree, law) (only in the Czech Republic).
- The operator is obliged to secure sufficient outlook during reversing from his position of the tractor driver. In case of insufficient outlook, the operator is obliged to call a competent and informed person.
- The operator must secure the arms of the rear TPS of the tractor in the transport position during road transport, i.e. prevent unexpected arm drop using the hydraulic arm control lever. At the same time, the arms of the rear TPS of the tractor must be secured against side swinging.
- During machine transport on roads, the operator must observe the valid laws and decrees that deal with this topic and which specify the relationships of the tractor axle load depending on transport speed

11 MACHINE ADJUSTMENT



Only adjust the machine when it is resting on the shares, e.g. when it is recessed (see below).

1. Set the longitudinal plane of the machine by positioning the lower arms of the tractor and by adjusting the drawbar of the tractor third point to secure the same depth of processing for the first, second and third row of the shares.
2. Recess the machine into the soil, leave it recessed and secure the undesirable falling of the rear frames with the roller to the main frame of the machine for lifting at headland using the bottom pin on the rear frame drawbar. Insert the pin in the nearest hole below the rear frame. Set the same depth on the left and right side of the machine.
3. Adjust the height and angle of the rear levellers. Proper leveller adjustment ensures even levelling of soil along the entire width of the machine.

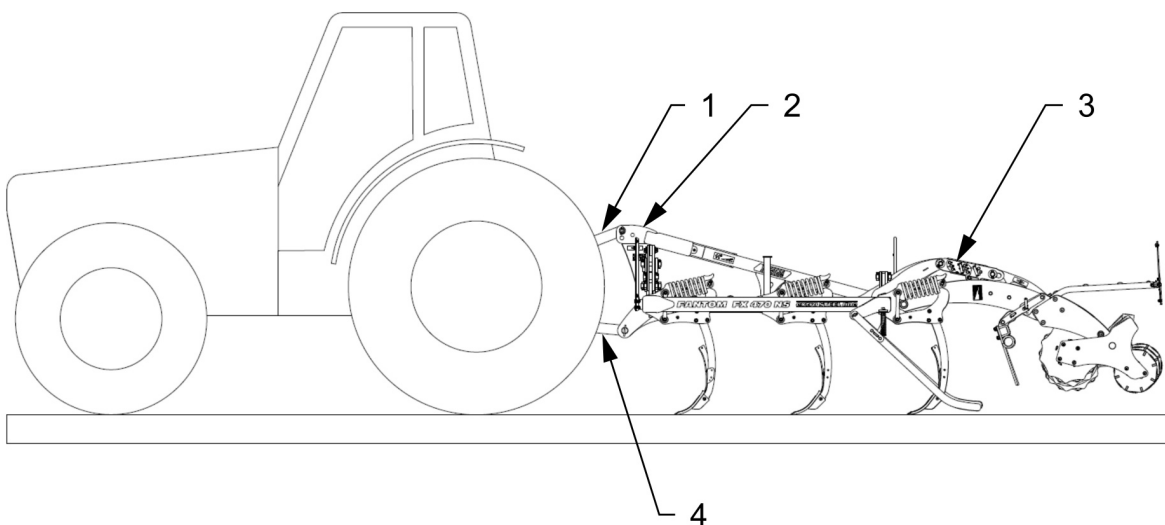

- 1 – Tractor's three-point pull rod
- 2 – Three-point flange
- 3 – Drawbar/piston rod, working depth setting
- 4 – Tractor arms

11.1 Adjusting the working depth of the machine

- The working depth is set by changing the position of the rollers against the frame of the machine. This change is done either mechanically using drawbars, or hydraulically using piston rods, according to the machine equipment.

Setting the working depth using drawbars

- Set the working depth of the machine using the top pin in the slot link of the rear frame of the roller according to Tab. 5. To release the pin, lift the machine in the tractor arms a bit.

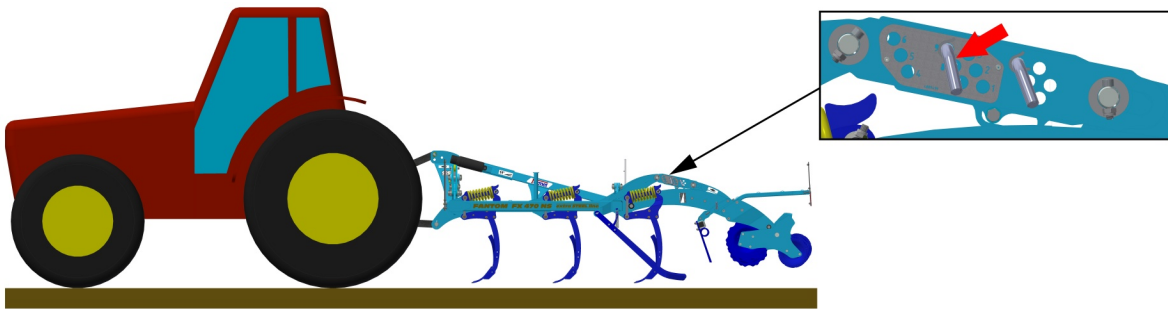

Tab.5

FANTOM FX 300 N, FX 350 N	
Top pin position	Approximate depth mm
1	40
2	50
3	60
4	75
5	90
6	105
7	120
8	135
9	150

- When the machine rests on the roller, move the bottom pin in the slot link of the rear frame as close as possible to the stop. Set the longitudinal plane of the bottom arms of the tractor to ensure the same depth of processing of all three chisel rows by positioning the lower arms of the tractor and by adjusting the drawbar of the tractor third point.

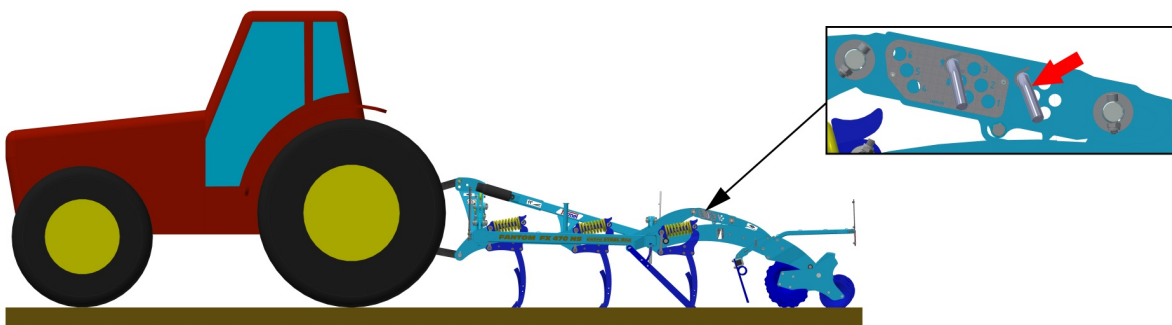

Setting the working depth using piston rods

- The working depth of the machine is set by various combinations of the spacers on the piston rods of the rollers.
- The individual combination of spacers for the required depth of the machine are stated in Tab. 6
- The stated working depths are only approximate and they may differ in relation to the individual soil conditions.

Tab.6

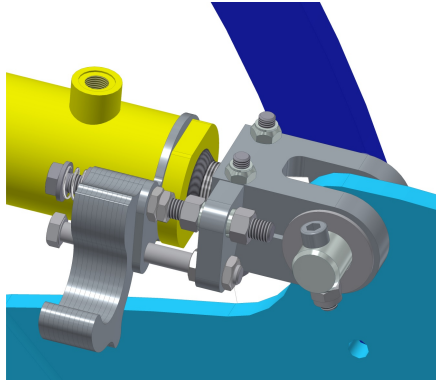

	30 / 1.2
	40 / 1.6
	50 / 2.0
	60 / 2.4
	70 / 2.8
	80 / 3.1
	90 / 3,5
	100 / 4.0
	110 / 4.3
	120 / 4.7
	130 / 5.1
	140 / 5.5
	150 / 5.9

[mm / in]

1 2

1. Number of spacers
2. Working depth

1. Lift the machine, attached to the tractor, and lower the rollers down to the maximum low position using the piston rods (piston rods are drawn out). Set the required number of spacers on the piston rods of the rollers.

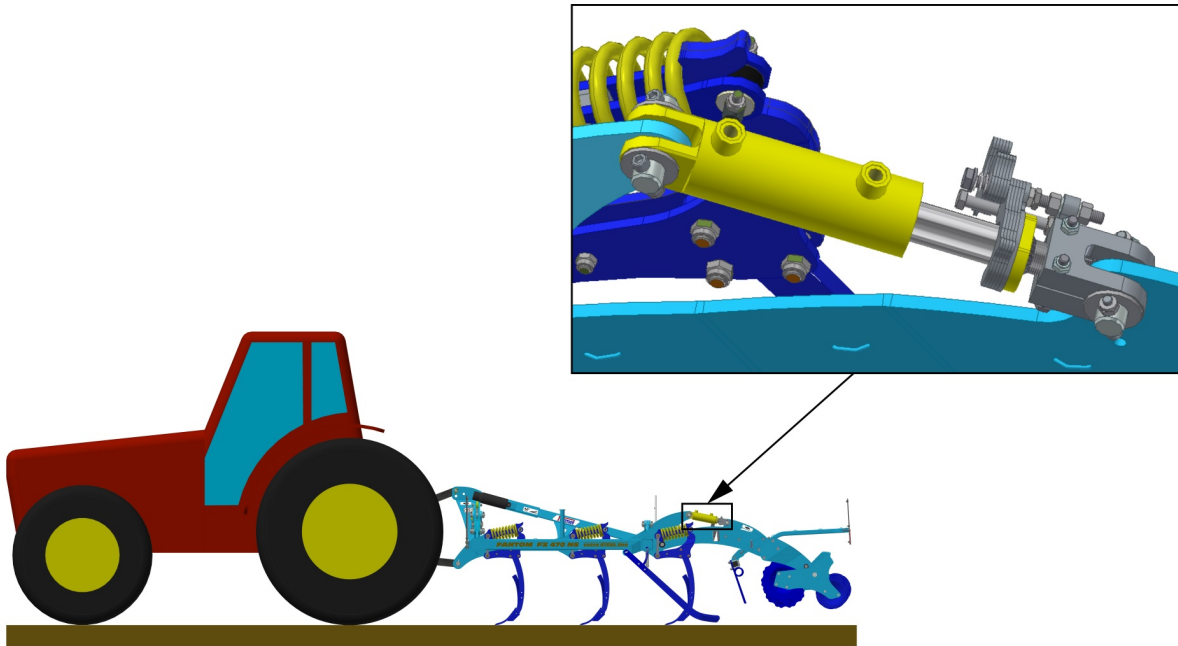

2. Draw the roller piston rods in to the maximum top position (piston rods are drawn in) so that the spacers placed on the piston rods are clamped firmly. Lower the machine, attached to the tractor, to the ground. Set the longitudinal plane of the bottom arms of the tractor to ensure the same depth of processing of all three chisel rows by positioning the lower arms of the tractor and by adjusting the drawbar of the tractor third point.

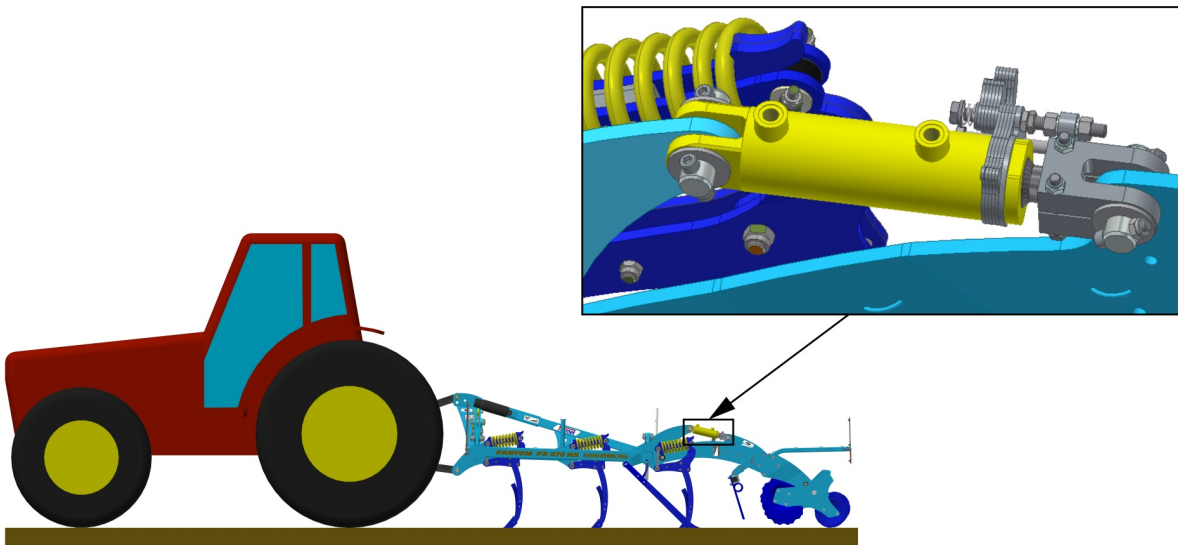

11.2 Setting side deflectors

- The deflector height needs to be set at various levels according to the type of soil and crop residue quantity (see the picture below).

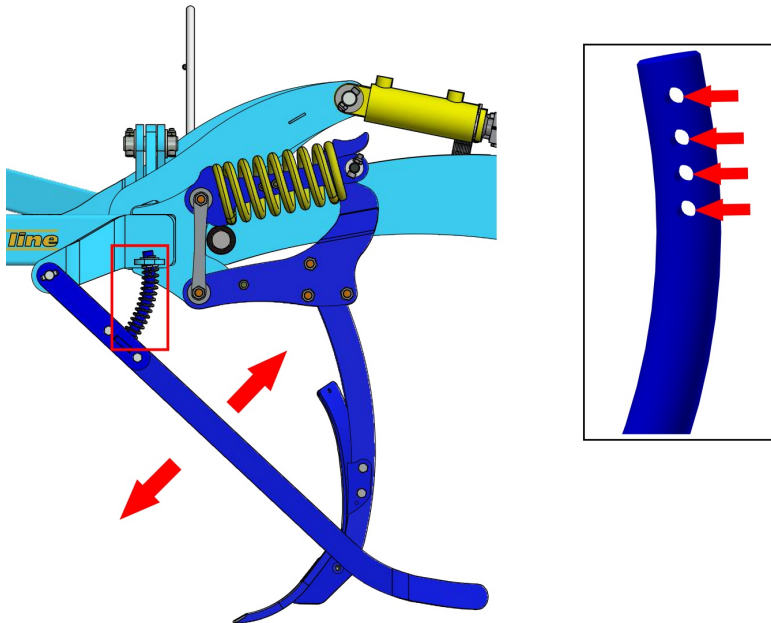

- Setting the distance of the deflector blade from the edge part.

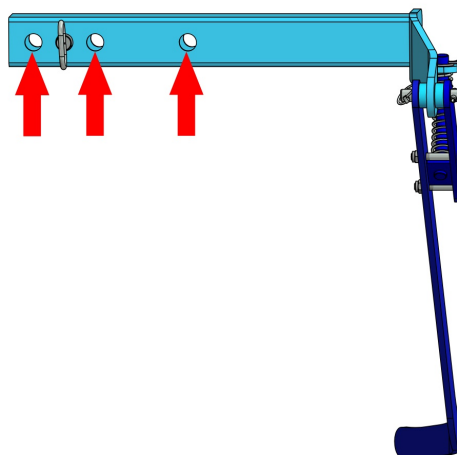
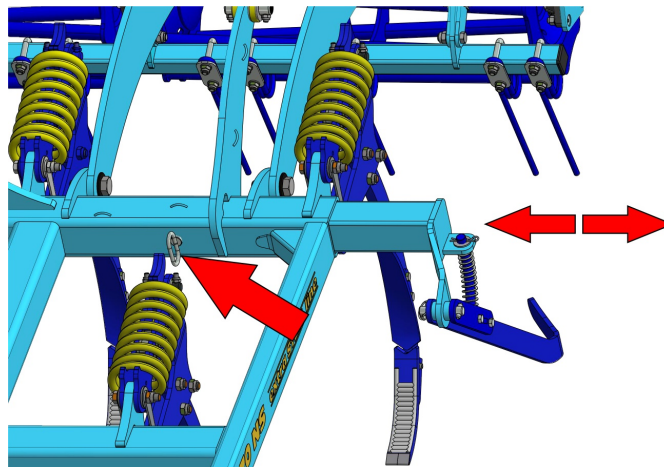

11.3 Share securing

The shares are protected against overload by compression springs that do not require any other adjustment.

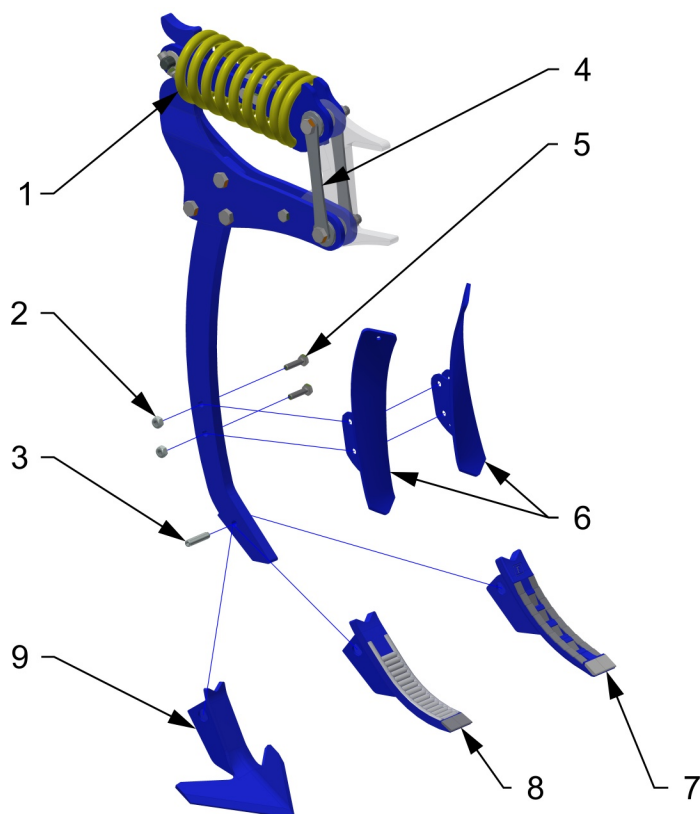

Pos.	Title
1	Compression spring
2	Nut
3	Spring pin
4	Connecting rod
5	Bolt
6	Top share with deflector
7	Chisel 50 MULTICARBIDE PRO
8	Chisel 50 MULTICARBIDE
9	V-plough

12 MACHINE MAINTENANCE AND REPAIRS



Observe the safety instructions for treatment and maintenance.

- If it is necessary to weld during the repair and have the machine connected to the tractor, it must have disconnected supply cables from the alternator and the accumulator.
- Check the tightening of all screw and other assembly connections at the machine before every use of the machine, furthermore continuously as needed.
- Continuously check the wear of the working bodies of the machine, possibly replace these worn working bodies with new ones.
- Adjustment, cleaning, and lubrication of the machine may only be performed with the machine at rest (i.e. the machine is standing and not working).
- When working on a lifted machine, use suitable support equipment supported at marked points or at points suitable for that.
- When working on a lifted machine, use suitable support equipment supported at marked points or at points suitable for that.
- During adjustment, cleaning, maintenance, and repair of the machine, you must secure those parts of the machine that could endanger the operator by falling or another movement.
- For catching the machine during handling using lifting equipment, use only the places marked with self-adhesive labels with the chain sign .
- Upon a failure or damage of the machine, immediately turn off the tractor's engine and secure against restarting, secure the machine against movement only then you can remove the failure.
- During repairs of the machine, use exclusively the genuine spare parts, suitable tools and protective equipment.



Do not clean hydraulic cylinders and bearings with a high-pressure cleaner or direct water stream. The seals and bearings are not watertight at high pressure.

13 MACHINE STORAGE

Long-term machine shutdown:

- Store the machine under a roof if possible.
- Store the machine on a flat and solid surface with sufficient load capacity.
- Clean the machine before storing and conserve so that it is not damaged in any way during storage. Pay special attention to all marked lubrication points and properly lubricate them according to the lubrication plan.
- Lay by the machine in the transport position rested on the rear roller and frames. Place a suitable support under the frames (e.g. crossbar) so that the tips of the chisels are above the ground. If you do not have a suitable support, dismantle the chisels.

 **If you lay by the machine on the chisels, they might get damaged by the weight of the machine. The damage might also incur when you lay by the machine on an uneven surface for a short time when the weight of the machine transfers only to some chisels.**

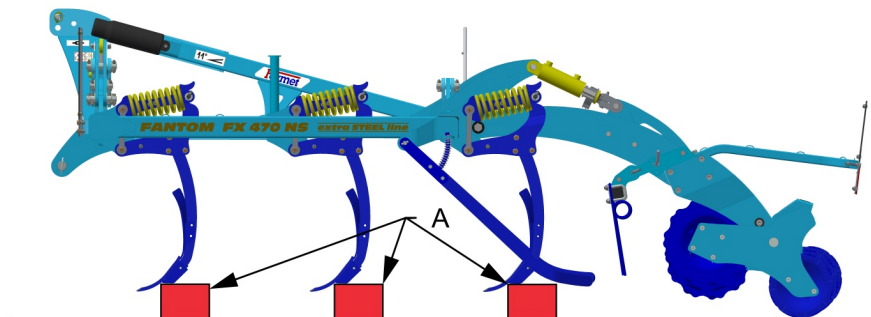

A -Sole piece

 **Secure the machine against access of unauthorised persons.**

14 MACHINE LUBRICATION SCHEDULE

- The machine is completely maintenance free when it comes to lubrication. Therefore, it is not necessary to lubricate the machine.

15 ENVIROMENTAL PROTECTION

- Regularly check the tightness of the hydraulic system.
- Preventively replace or repair hydraulic hoses, possibly further parts of the hydraulic system showing signs of damage, before oil leaks occur.
- Check the condition of hydraulic hoses and perform their timely replacement. The service life of hydraulic hoses includes the time, when they were stored.
- Handle oils and greases according to valid waste laws and regulations.

16 MACHINE DISPOSAL AFTER SERVICE LIFE EXPIRY

- The operator must ensure during machine disposal that steel parts and parts, in which hydraulic oil or lubricating grease moves are differentiated.
- Steel parts must be cut by the operator while observing safety regulations and handed over to the secondary raw material collection point. He must proceed with other parts according to valid laws about waste.

17 SERVICING AND WARRANTY CONDITIONS

17.1 Servicing

Servicing is secured by the dealer after consulting with the manufacturer, possibly directly by the manufacturer. Spare parts then using the sales network by individual sellers in the entire country. Use only the spare parts according to the spare parts catalogue officially issued by the manufacturer.

17.2 Warranty

1. The manufacturer provides a warranty of 24 months for these machine parts: main frame, axle, and machine tow bar. For other parts of the machine, the manufacturer provides a warranty of 12 months. The warranty is provided from the date of sale of the new machine to the end user (consumer).
2. The warranty applies to hidden defects that will show in the warranty period with proper use of the machine and while fulfilling the conditions stated in the operating manual.
3. The warranty does not apply to wearable spare parts, i. e. regular mechanical wear and tear of replaceable parts of the working sections (shares, edges, etc.).
4. The warranty does not apply to indirect consequences of possible damage, such as service life decrease etc.
5. The warranty is bound to the machine and is not void upon an owner change.
6. The warranty is limited to the disassembly and assembly, possibly replacement or repair of the defective part. The decision, whether to replace or repair the defective part, is up to the contractual workshop of Farmet.
7. During the warranty period, only the authorised servicing technician of the manufacturer may perform repairs or other interventions into the machine. In the opposite case, the warranty will not be acknowledged. This provision does not apply to the replacement of wearable spare parts (see point 3).
8. The warranty is conditioned by using the genuine spare parts of the manufacturer.

2010/001/02

(CZ) **ES PROHLÁŠENÍ O SHODĚ**
 (GB) **CERTIFICATE OF CONFORMITY**
 (D) **EG-KONFORMITÄTSERKLÄRUNG**
 (F) **DÉCLARATION CE DE CONFORMITÉ**
 (RU) **СЕРТИФИКАТ СООТВЕТСТВИЯ ЕС**
 (PL) **DEKLARACJA ZGODNOŚCI WE**

1. (CZ) My (GB) We (D) Wir (F) Nous (RU) Мы (PL) My: **Farmet a.s.**
 Jiřínková 276
 552 03 Česká Skalice
 Czech Republic
 DIČ: CZ46504931
 Tel/Fax: 00420 491 450136

(CZ) Vydáváme na vlastní zodpovědnost toto prohlášení. (GB) Hereby issue, on our responsibility, this Certificate. (D) Geben in alleiniger Verantwortung folgende Erklärung ab. (F) Publiions sous notre propre responsabilité la déclaration suivante. (RU) Под свою ответственность выдаем настоящий сертификат. (PL) Wydajemy na własną odpowiedzialność niniejszą Deklarację Zgodności.

2. (CZ) Strojní zařízení: - název : **Dlátový kyřič**
 (GB) Machine: - name : **Chisel cultivator**
 (D) Fabrikat: - Bezeichnung : **Meißelgrubber**
 (F) Machinerie: - dénomination : **Cultivateur à siceaux**
 (RU) Сельскохозяйственная машина: - наименование : **Чизельный культиватор**
 (PL) Urządzenie maszynowe: - nazwa : **Spulchniarka dłutowa**
- typ, type : **FANTOM**
 - model, modèle : **FX 300 N**
 - (CZ) výrobní číslo :
 - (GB) serial number
 - (D) Fabriknummer
 - (F) n° de production
 - (RU) заводской номер
 - (PL) numer produkcyjny:

3. (CZ) Příslušná nařízení vlády: č.176/2008 Sb. (směrnice 2006/42/ES). (GB) Applicable Governmental Decrees and Orders: No.176/2008 Sb. (Directive 2006/42/ES). (D) Einschlägige Regierungsverordnungen (NV): Nr.176/2008 Slg. (Richtlinie 2006/42/ES). (F) Décrets respectifs du gouvernement: n°.176/2008 du Code (directive 2006/42/CE). (RU) Соответствующие постановления правительства: № 176/2008 Сб. (инструкция 2006/42/ES). (PL) Odpowiednie rozporządzenia rządowe: nr 176/2008 Dz.U. (Dyrektywa 2006/42/WE).

4. (CZ) Normy s nimiž byla posouzena shoda: (GB) Standards used for consideration of conformity: (D) Das Produkt wurde gefertigt in Übereinstimmung mit folgenden Normen: (F) Normes avec lesquelles la conformité a été évaluée: (RU) Нормы, на основании которых производилась сертификация: (PL) Normy, według których została przeprowadzona ocena: ČSN EN ISO 12100, ČSN EN ISO 4254-1.

(CZ) Schválil (GB) Approve by dne: 01.06.2012
 (D) Bewilligen (F) Approuvé
 (RU) Утвердил (PL) Uchwalil

p. Gavlas Dušan
 technický ředitel
 Technical director



Farmet a.s.
 Jiřínková 276
 552 03 Česká Skalice
 DIČ CZ46504931
 3P

V České Skalici dne: 01.06.2012

Ing. Karel Žďárský
 generální ředitel společnosti
 General Manager

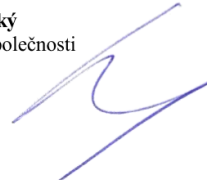

2010/002/02

ES PROHLÁŠENÍ O SHODĚ
CE CERTIFICATE OF CONFORMITY
EG-KONFORMITÄTSERKLÄRUNG
DÉCLARATION CE DE CONFORMITÉ
СЕРТИФИКАТ СООТВЕТСТВИЯ ЕС
DEKLARACJA ZGODNOŚCI WE

1. **My We Wir Nous Мы My:** **Farmet a.s.**
Jiřínková 276
552 03 Česká Skalice
Czech Republic
DIČ: CZ46504931
Tel/Fax: 00420 491 450136

Vydávám na vlastní zodpovědnost toto prohlášení. Hereby issue, on our responsibility, this Certificate. Geben in alleiniger Verantwortung folgende Erklärung ab. Publiions sous notre propre responsabilité la déclaration suivante. Под свою ответственность выдаем настоящий сертификат. Wydajemy na własną odpowiedzialność niniejszą Deklarację Zgodności.

2. **Strojní zařízení:** - název : **Dřátový kypřič**
Machine: - name : **Chisel cultivator**
Fabrikat: - Bezeichnung : **Meißelgrubber**
Machinerie: - dénomination : **Cultivateur à siceaux**
Сельскохозяйственная машина: - наименование : **Чизельный культиватор**
Urządzenie maszynowe: - nazwa : **Spulchniarka dłutowa**
- typ, type : **FANTOM**
- model, modèle : **FX 350 N**
- výrobní číslo :
- serial number
- Fabriknummer
- n° de production
- заводской номер
- numer produkcyjny:

3. **Príslušná nařízení vlády: č.176/2008 Sb. (směrnice 2006/42/ES).** **Applicable Governmental Decrees and Orders: No.176/2008 Sb. (Directive 2006/42/ES).** **Einschlägige Regierungsverordnungen (NV): Nr.176/2008 Slg. (Richtlinie 2006/42/ES).** **Décrets respectifs du gouvernement: n°.176/2008 du Code (directive 2006/42/CE).** **Соответствующие постановления правительства: № 176/2008 Сб. (инструкция 2006/42/ES).** **Odpowiednie rozporządzenia rządowe: nr 176/2008 Dz.U. (Dyrektywa 2006/42/WE).**

4. **Normy s nimiž byla posouzena shoda:** **Standards used for consideration of conformity:** **Das Produkt wurde gefertigt in Übereinstimmung mit folgenden Normen:** **Normes avec lesquelles la conformité a été évaluée:** **Нормы, на основании которых производилась сертификация:** **Normy, według których została przeprowadzona ocena: ČSN EN ISO 12100, ČSN EN ISO 4254-1.**

Schválil Approve by dne: 01.06.2012
Bewilligen Approuvé
Утвердил Uchwalil

p. Gavlas Dušan
technický ředitel
Technical director

Farmet a.s.
Jiřínková 276
552 03 Česká Skalice
DIČ CZ46504931
3P

V České Skalici dne: 01.06.2012

Ing. Karel Žďárský
generální ředitel společnosti
General Manager